

# Transport properties of electrospun hydrogel nanofilaments: perspective use for drug delivery and tissue repair

**Tomasz A. Kowalewski**

Sylwia Pawłowska, Filippo Pierini

Department of Biosystems and Soft Matter

IPPT PAN, Warszawa



**POLISH** NATIONAL AGENCY  
FOR ACADEMIC EXCHANGE

**The University of Illinois at Chicago September 5-12, 2019**

## Drug Delivery System Challenges

**Targeted drug delivery:** systems allow selective targeting of the drug to a specific tissue, organ or specific cells inside the body to achieve a targeted drug action.

**Controlled release drug delivery:** systems capable to maintain the adequate end desired release of drug over an extended period of time.

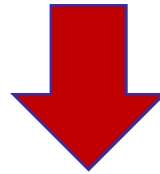

## Nanomedicine

- Nanocarriers

- Drug

- Target

- Environment

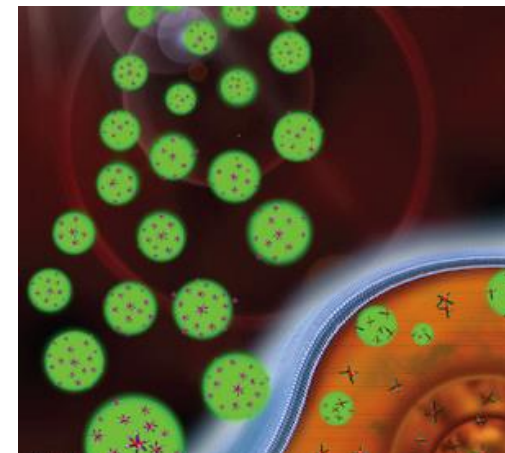

# INTRODUCTION

## Nanomaterial-based Drug Delivery System

- Capable of achieving high drug loading
- Inert
- Biocompatible
- Mechanically strong
- Comfortable for the patient
- Readily processable
- Safe from accidental release
- Simple to administer
- Easy to fabricate and sterilize
- Free of leachable impurities

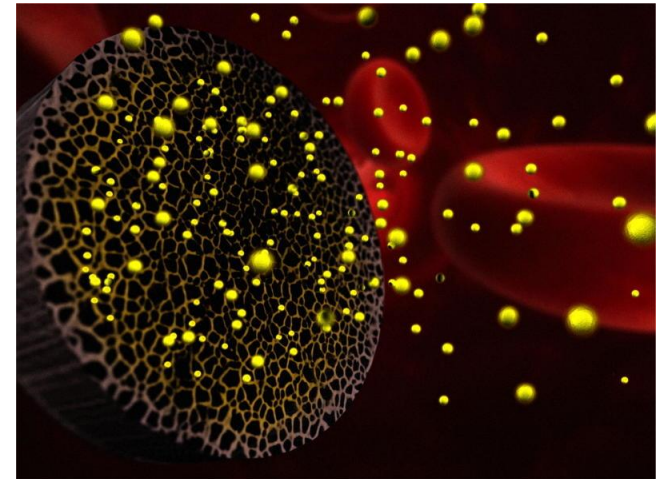

# INTRODUCTION

## Barriers to nanovehicle transport

- Hemo-Rheology
- Endothelial and Epithelial Barrier
- Reticuloendothelial System
- Blood–brain barrier
- Cell Membrane
- Nuclear membrane
- Ionic & Molecular Pumps

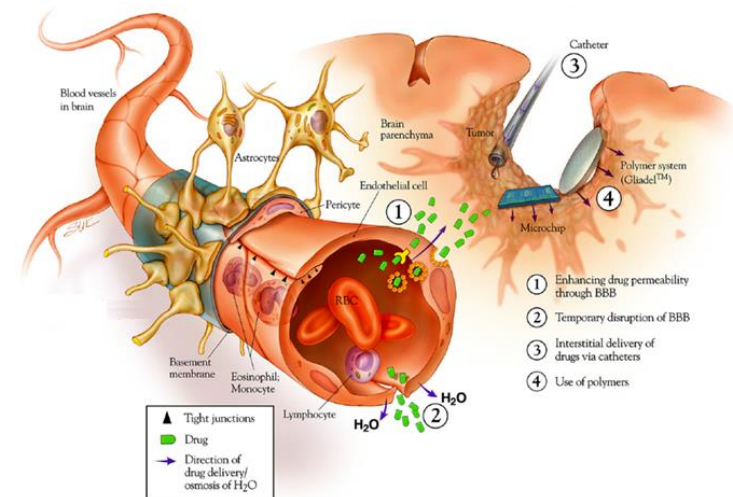

# INTRODUCTION

## Hydrogel characteristics

- three dimensional networks of hydrophilic polymers that are insoluble but can swell in water
- solid like and liquid like properties in one material
- biocompatibility
- controlled drug release

## Mechanical properties are influenced by:

- type and composition of monomers
- cross-linking
- environmental factors (e.g. temperature, pH, ionic strength, light, electric and magnetic fields)

# INTRODUCTION

## Nanofilaments

- High deformability
- Coiling/uncoiling properties
- Capability to pass through crowded environments and pores

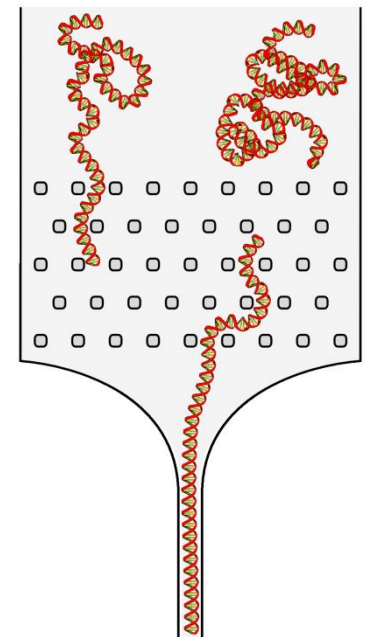
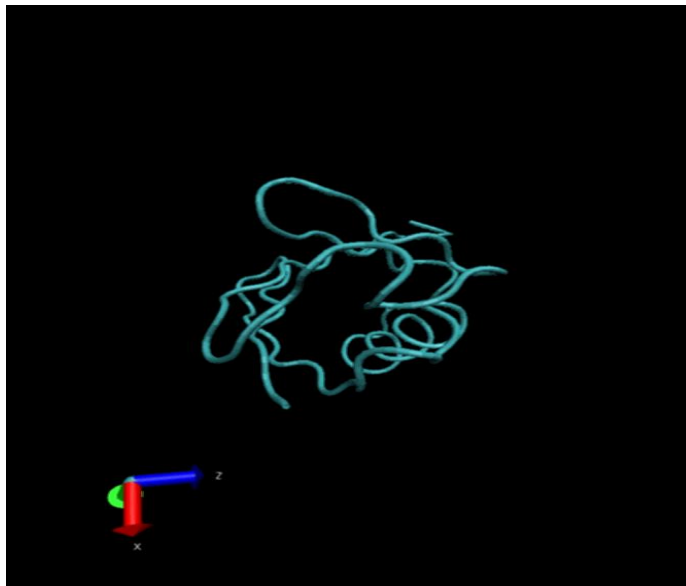

Production of flexible nanofilaments which can be used as drug carriers, with deformability and elasticity resembling those of long DNA chains

Mechanical characterization of highly deformable hydrogel nanofilaments by using AFM nanoindentation, Brownian motion and bending dynamic techniques.

# MATERIALS PRODUCTION

## Hydrogels

Polyacrylamide

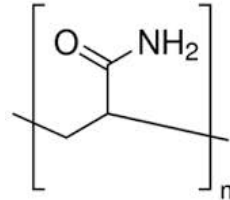

**Materials:**

- Acrylamide (Aam)
- N,N'-methylene bisacrylamide (BIS-Aam)
- ammonium persulfate (APS)
- N,N,N',N'-tetramethylethylenediamine (TEMED)
- Bovine Serum Albumin with fluoresceine (BSA-FITC)

**Samples:**

- EA1 mass ratio of AAm/BIS-AAm (w/w): 37.5:1
- EA2 mass ratio of AAm/BIS-AAm (w/w): 20:1
- EA3 mass ratio of AAm/BIS-AAm (w/w): 4:1

Poly(N-isopropylacrylamide)

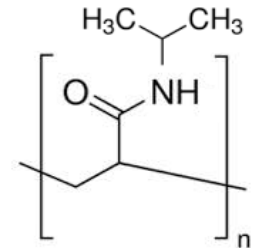

**Materials:**

- N,N-isopropylacrylamide (NIPAAm),
- N,N'-methylene bisacrylamide (BIS-Aam)
- ammonium persulfate (APS)
- N,N,N',N'-tetramethylethylenediamine (TEMED)
- Bovine Serum Albumin with fluoresceine (BSA-FITC)

**Samples:**

- EN1 mass ratio of NIPAAm/BIS-AAm (w/w): 37.5:1
- EN2 mass ratio of NIPAAm/BIS-AAm (w/w): 20:1
- EN3 mass ratio of NIPAAm/BIS-AAm (w/w): 4:1

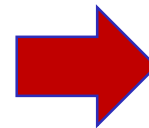
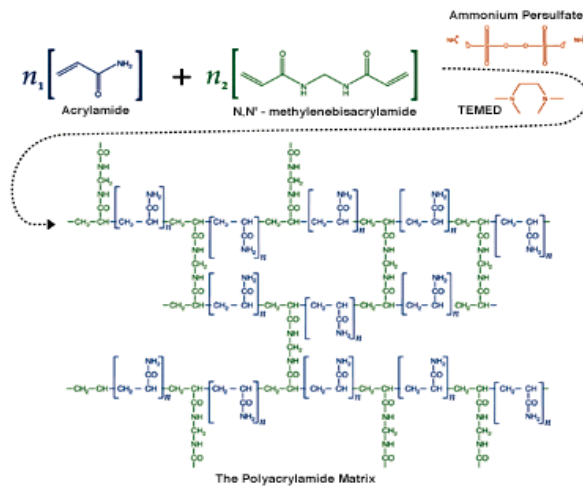

**Polymerization**



# MATERIALS PRODUCTION

## Core-Shell Electrospun Fibers

Core:

Hydrogels

Shell:

Poly(L-lactide-co-caprolactone) (70% L-lactide and 30% caprolactone unit)(PLCL)

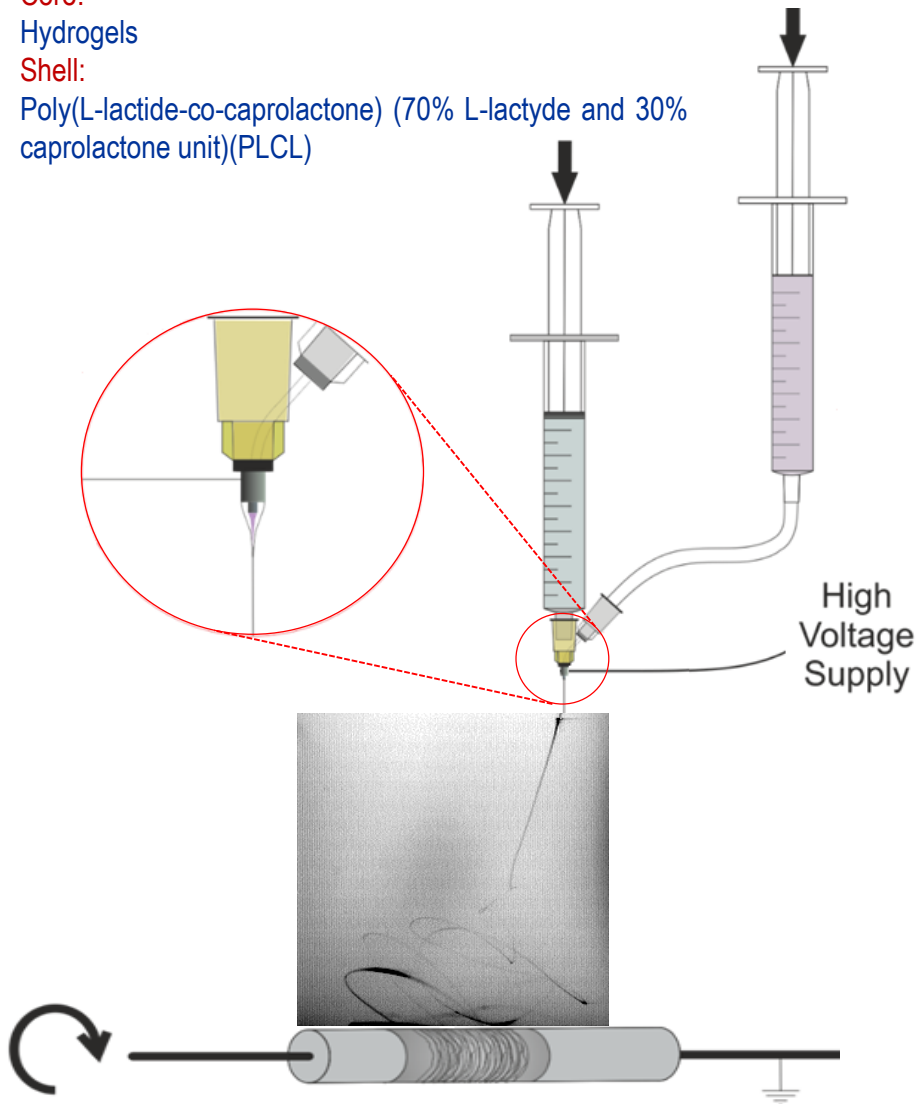

Short filaments

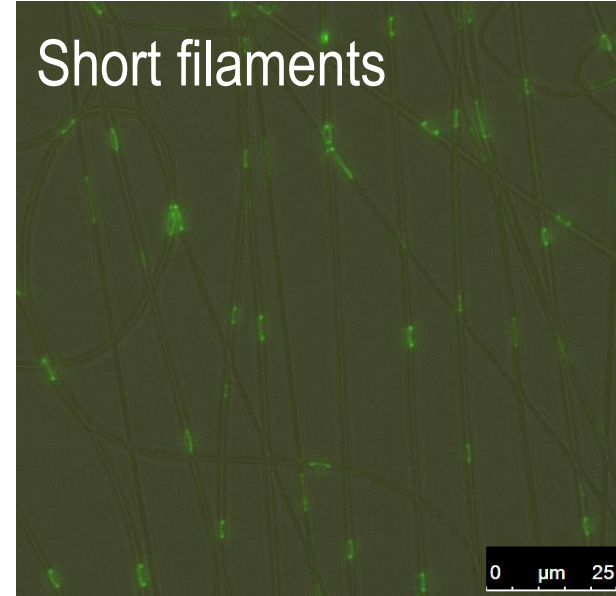

Long filaments

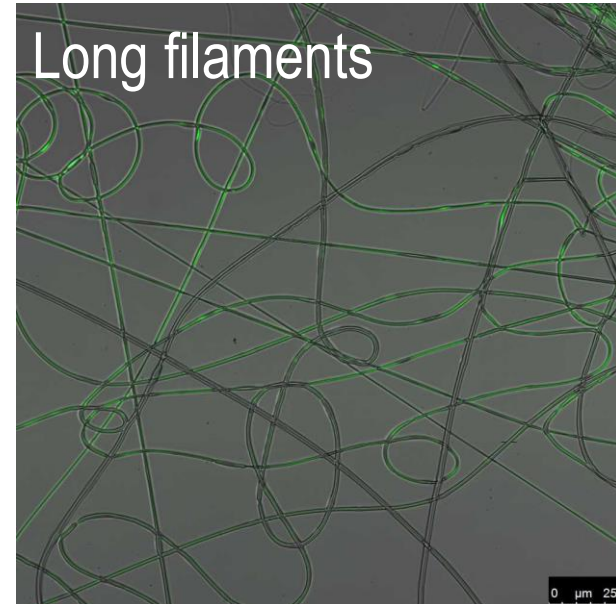

# MATERIALS PRODUCTION

## Shell Dissolution

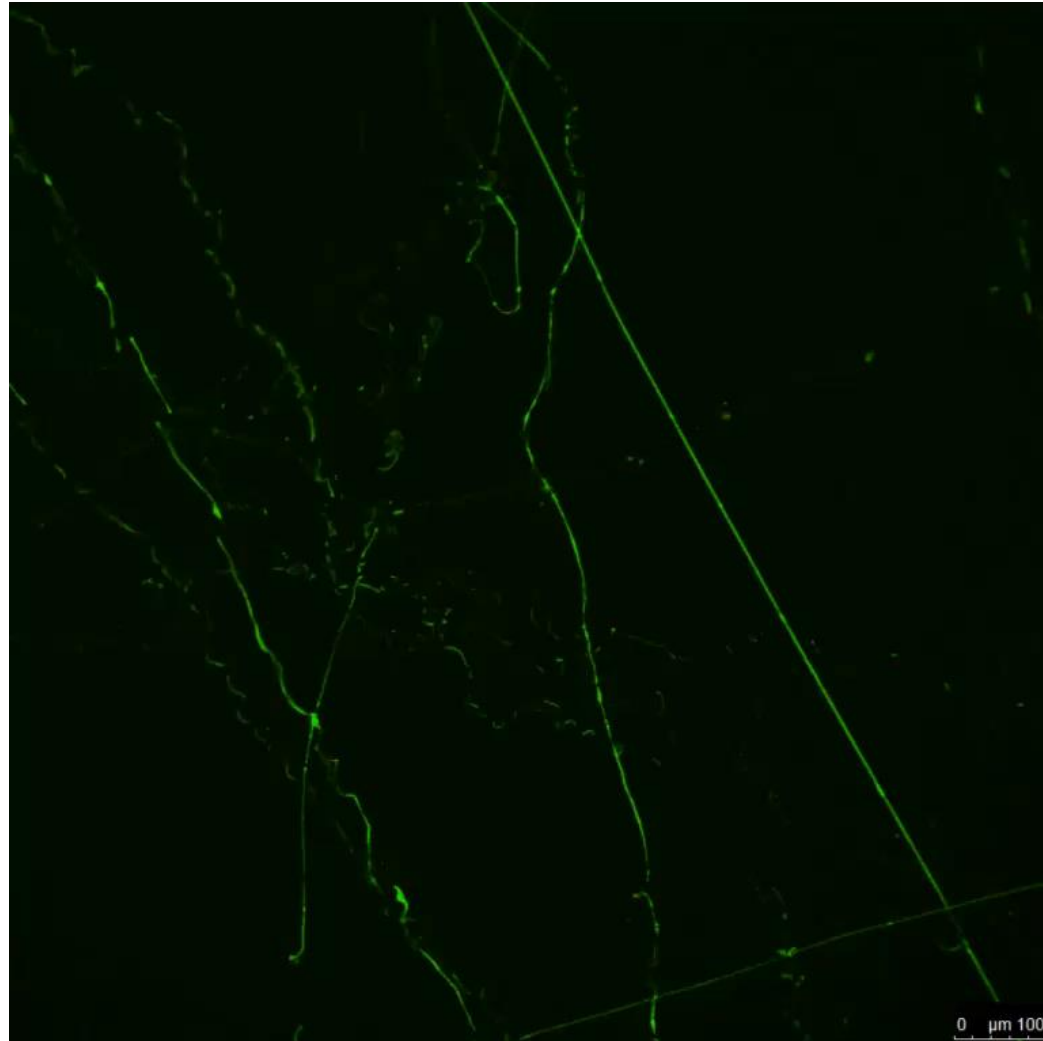

Shell dissolution and filaments extraction in  
N,N-dimethylformamide (DMF)

# CHARACTERIZATION

## Protein Release

### Materials:

N,N-isopropylacrylamide (NIPAAm),  
N,N'-methylene bisacrylamide (BIS-Aam)  
ammonium persulfate (APS)  
N,N,N',N'-tetramethylethylenediamine (TEMED)  
Bovine Serum Albumin with fluoresceine (BSA-FITC)

### Samples:

- EN1 mass ratio of NIPAAm/BIS-AAm (w/w): 37.5:1  
0.7% <sub>w/w</sub> of BSA-FITC in hydrogel

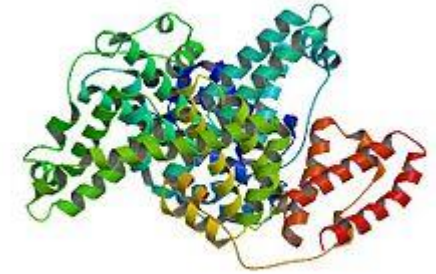

Bovine Serum Albumin

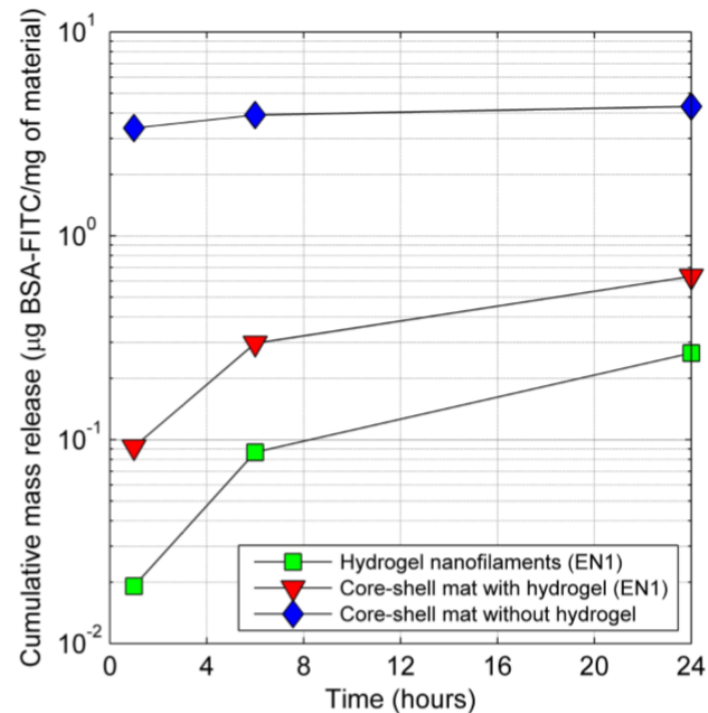

# CHARACTERIZATION

## Morphology

SEM

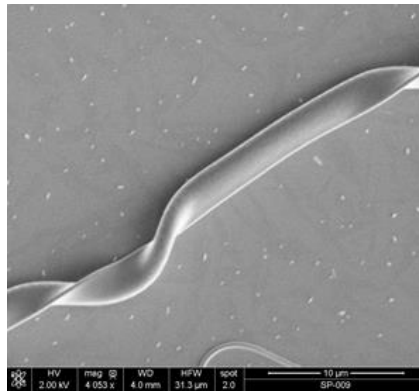

Ribbon-like core-shell  
PLCL/PAAm nanofibre (EA3)

TIRF



Fluorescent nanofilaments  
extracted as core from nanofibre

AFM

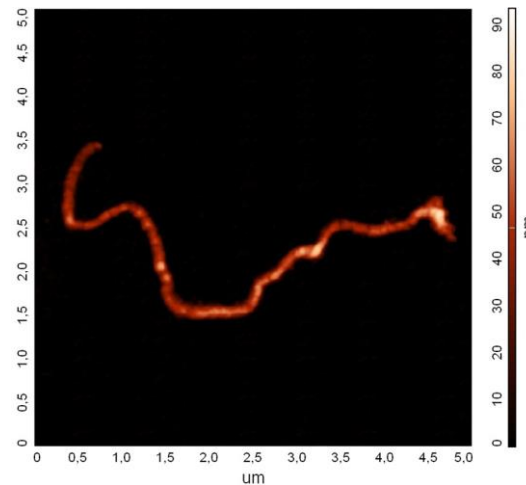

Ribbon-like nanofilament (EA1): contour length 7  $\mu\text{m}$ , width 128 nm, height 39 nm

# CHARACTERIZATION

## Morphology

### FILAMENTS WIDTH

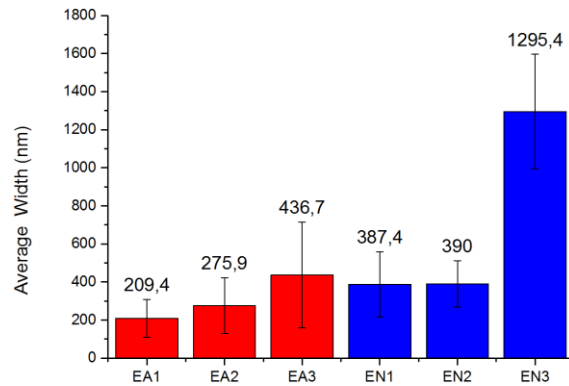

### FILAMENTS HEIGHT

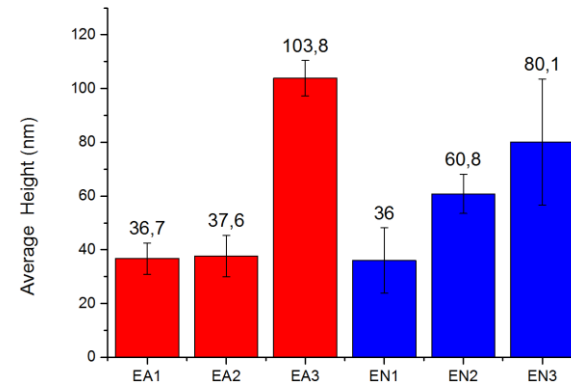

### FILAMENTS EQUIVALENT DIAMETER

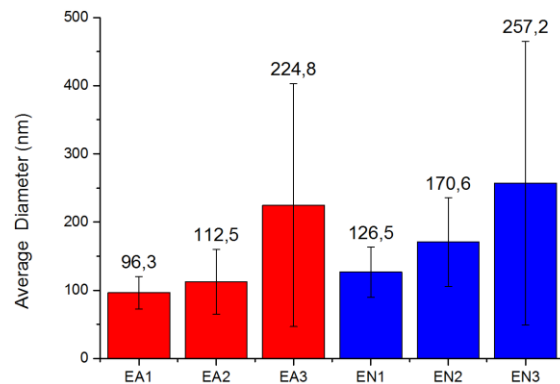

### FILAMENTS WIDTH / HEIGHT RATIO

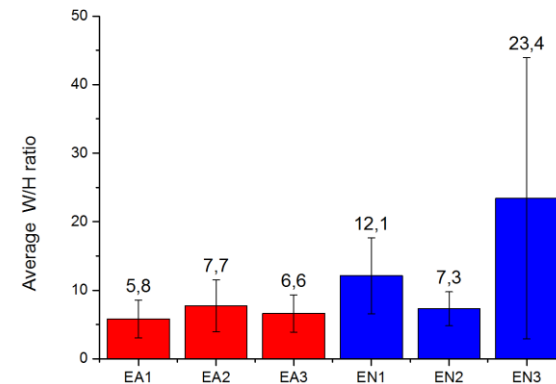

# CHARACTERIZATION

## AFM Nanoindentation

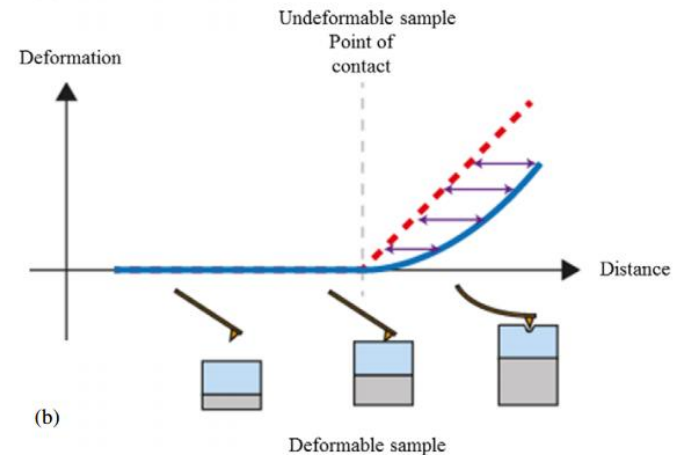
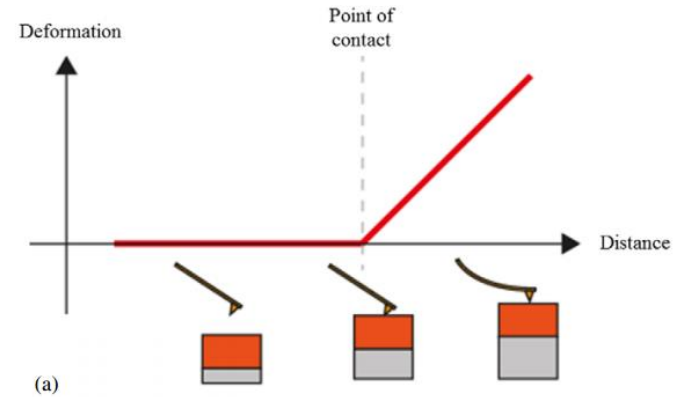
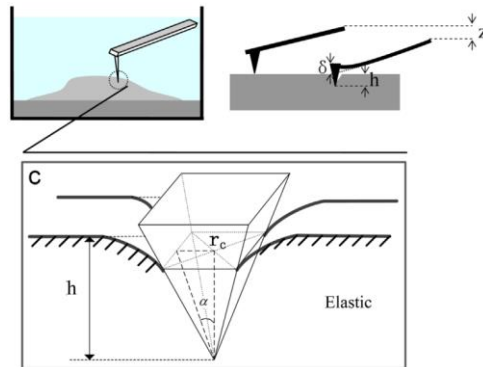
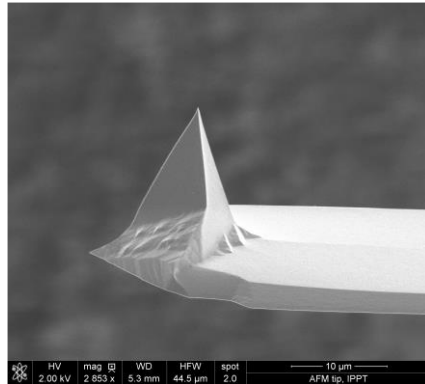

## Hertz Model

$$E = F \cdot \frac{3}{4} \cdot \frac{1 - \nu^2}{\sqrt{r} \cdot \delta^2}$$

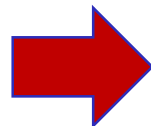

where  $F$  is the applied force,  $E$  is elastic modulus of the sample,  $\nu$  is the Poisson's ratio of the sample,  $\delta$  is the indentation depth and  $r$  is the equivalent radius for a spherical indenter

# CHARACTERIZATION

## Thermal Fluctuations

Diffusion coefficients:

$$D_a = \frac{k_B T [\ln(L/R) - 0.5]}{2\pi\eta_s L}$$

$$D_b = \frac{k_B T [\ln(L/R) + 0.5]}{4\pi\eta_s L}$$

$$D_\theta = \frac{3k_B T [\ln(L/R) - 0.5]}{\pi\eta_s L^3}$$

$k_B$  is Boltzmann's constant  
 T is the absolute temperature  
 $\eta_s$  is the viscosity of the water  
 $\theta$  is the rotation angle  
 L, R are the length and radius of the filament

Cosine correlation method

$$\langle \cos\theta(s) \rangle = e^{-L/2L_p}$$

L is the contour filament length  
 $L_p$  is the persistence length  
 $\theta$  is the angle between two unit tangent vectors

Persistence length is the length over which correlations in the direction of the tangent are lost.  $L_p$  is correlated to the Young's Modulus (E):

$$L_p = \frac{E I}{k_B T}$$

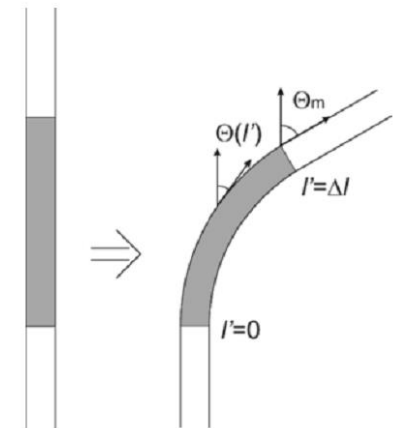
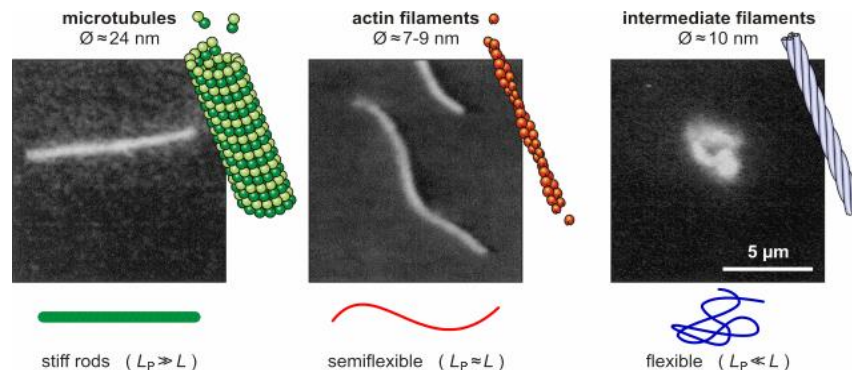

# CHARACTERIZATION

## Thermal Fluctuations

Contour length:  $15.6 \mu\text{m}$

Persistence length:  $598 \mu\text{m}$

Experimental diffusion coefficients:

$$D_a = 0.266 \mu\text{m}^2$$

$$D_b = 0.070 \mu\text{m}^2$$

$$D_{\text{rot}} = 0.0023 \text{ rad}^2$$

Theoretical diffusion coefficients:

$$D_a = 0.182 \mu\text{m}^2$$

$$D_b = 0.116 \mu\text{m}^2$$

$$D_{\text{rot}} = 0.0044 \text{ rad}^2$$





# CHARACTERIZATION

## Thermal Fluctuations

Bending dynamics of a nanofilament of contour length  $21.5 \mu\text{m}$ . Red lines indicate arms of the fibre starting from the centre of the fibre mass. The angle between the red lines was measured to assess flexibility. The time interval between frames is  $t = 0.25 \text{ s}$ .

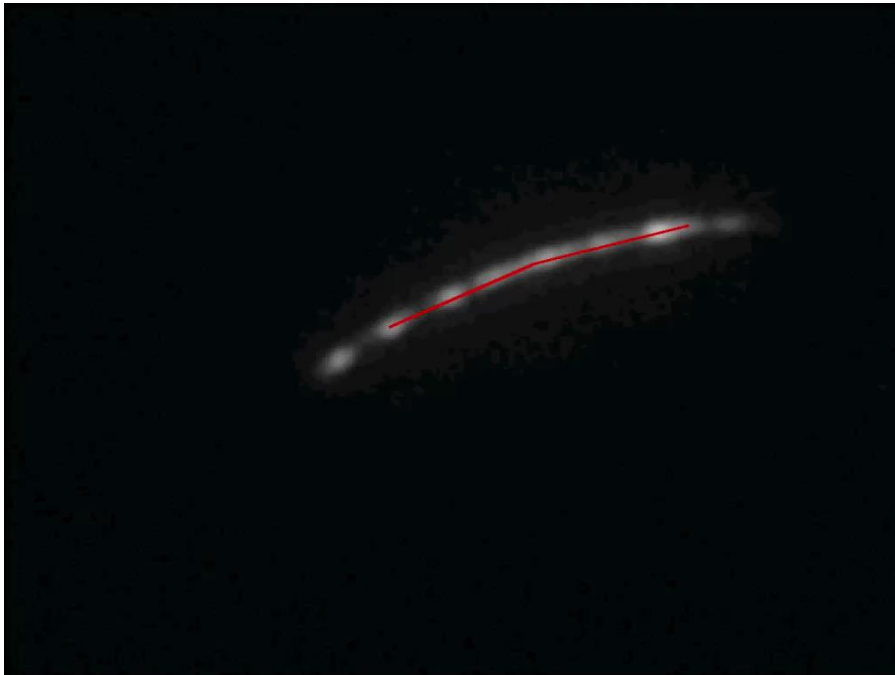
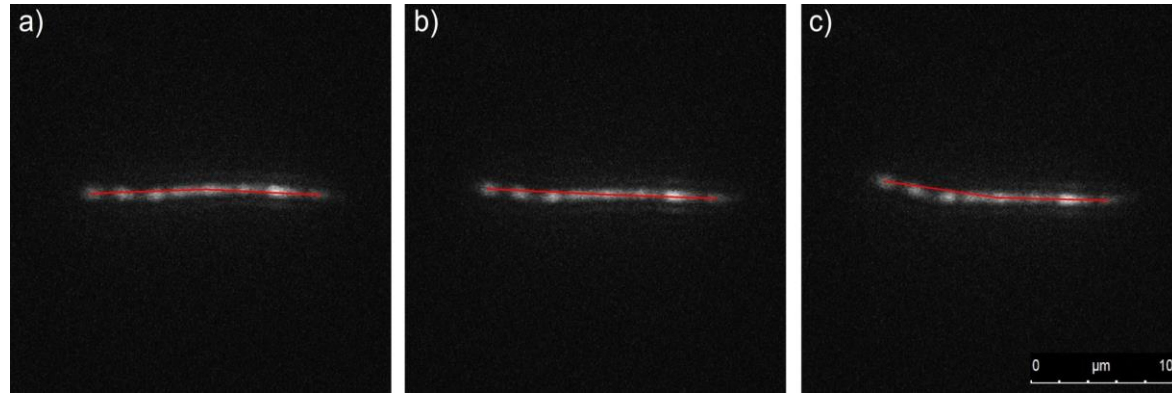

# CHARACTERIZATION

## Thermal Fluctuations

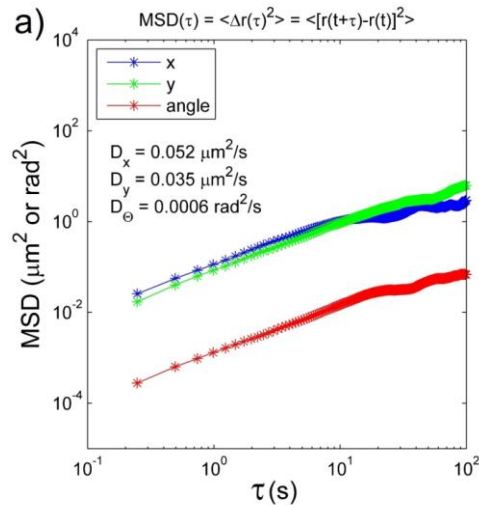

Mean square displacement of a filament of contour length  $21.5 \mu\text{m}$  as a function of lag time

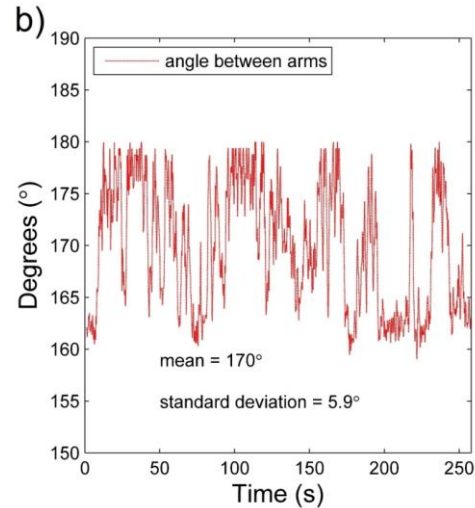

Angle between arms of the bending filament as a function of time

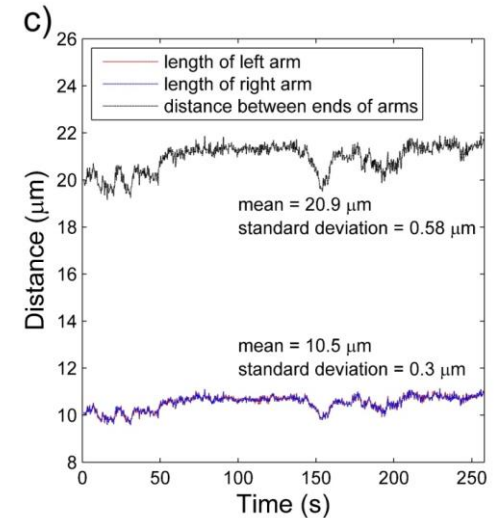

Length of left and right arm of the bending filament, and distance between both ends of the arms.

# CHARACTERIZATION

## Mechanical Properties

Monomer mass ratio	Young modulus E (kPa)		
	AFM indentation	Cosine correlation	Flow
NIPAAm:BIS-AAm			
37.5:1	—	4.5±0.4	2.3
20:1	8.50±1.19	3.1±1.7	—
4:1	18.11±4.85	3.8±1.1	—
AAm:BIS-AAm			
37.5:1	4.06±1.18	6.1±2.6	—
20:1	15.80±2.77	5.0±1.1	—
4:1	55.82±5.64	5.8±0.8	—

# Understanding transport of nano-objects

## Lateral migration of particles in a tube flow

### Numerical, droplet

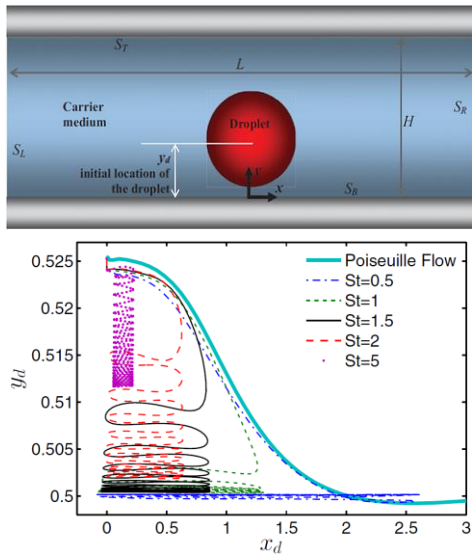

### Theoretical, particle

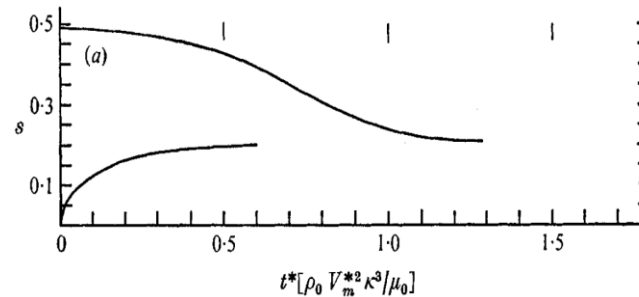

### Experiment, RBC

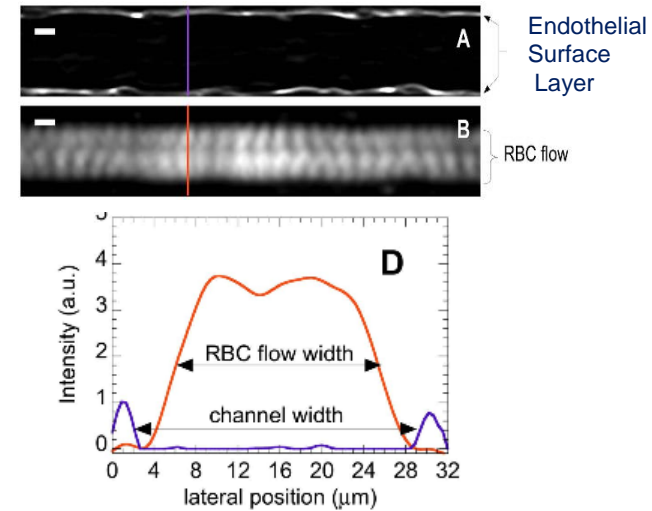

Tsvirkun D., Grichine A., Duperray A., Misbah C., Bureau L.: Microvasculature on a chip: study of the Endothelial Surface Layer and the flow structure of Red Blood Cells. Nature Scientific Reports (2017), 7:45036.

Ho B. P., Leal L. G.: Inertial migration of rigid spheres in two-dimensional unidirectional flows. J. Fluid Mech. (1974), 65(2), pp. 365-400.

Chaudhury K., Mandal S., Chakraborty S.: Droplet migration characteristics in confined oscillatory microflows. Physical Review E (2016), 93, 023106.

# Proposed experimental model of long polymeric chains

Highly deformable polymer nano-object undergoing a strong deformation under the influence of mechanical and physical phenomena.

- Verification of the existing theoretical models
- Checking their potential application

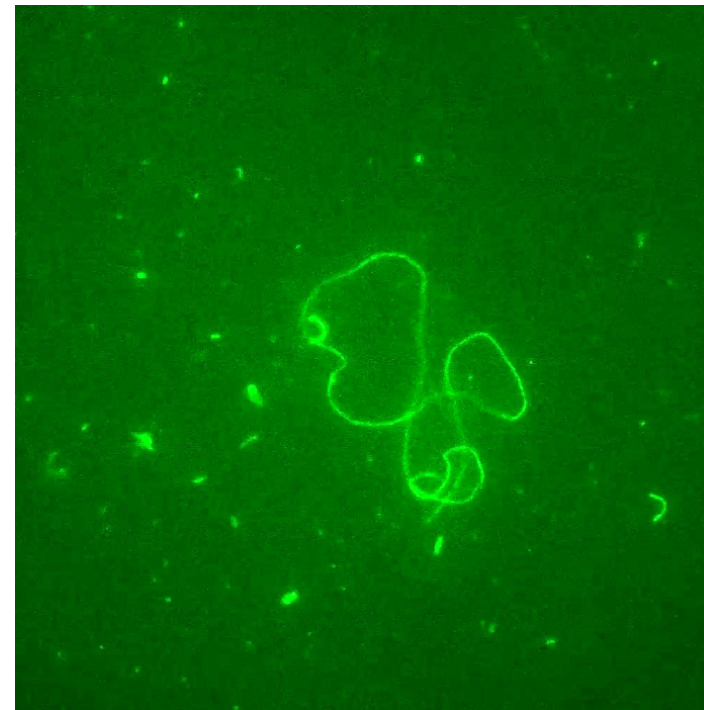

# Mechanical parameters of the filament

## Persistence Length

Thermal fluctuations



Persistence length

$$L_p = \frac{EI}{k_B T}$$

$I = \pi R^4/4$  – moment of inertia  
 $E$  – Young modulus

Cosine correlation method

$$\langle \cos\theta(s) \rangle = e^{-L/2L_p}$$

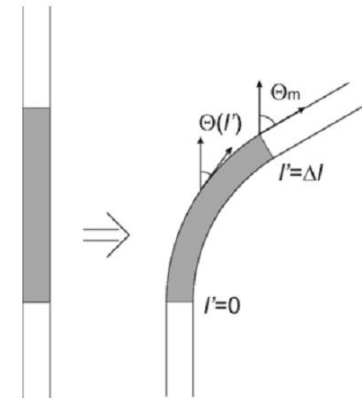
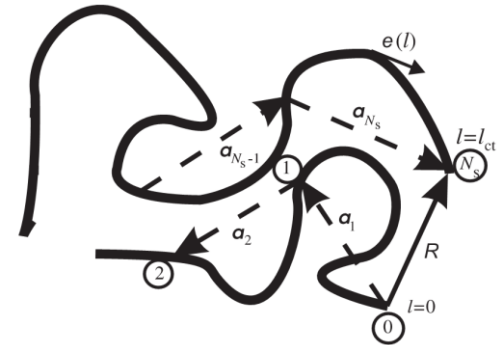

# Cross-flow migration of long polymer objects

Stiff filaments  
kinesin microtubules  
 $L_p/L > 1$

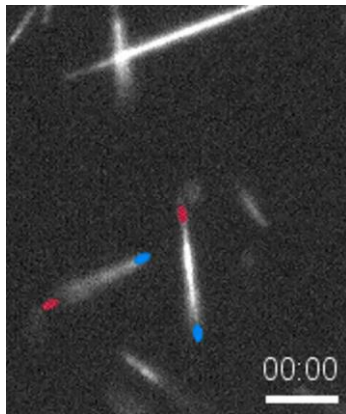

to channel wall

Semiflexible filaments  
actin filaments  
 $L_p/L \sim 1$

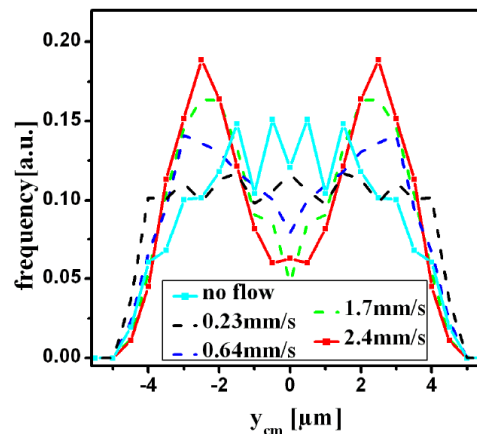

between wall and center of the channel

Flexible filaments  
DNA  
 $L_p/L < 1$

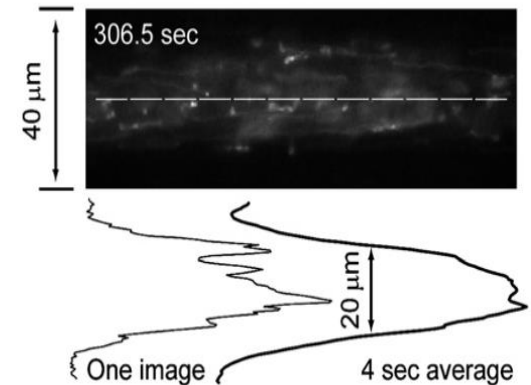

channel center

Sanches T. et al., Spontaneous motion in hierarchically assembled active matter, Nature 491 (2012)

Saintillan D., et al. Effect of flexibility on the shear-induced migration of short-chain polymers in parabolic channel flow, Journal of Fluid Mechanics (2006), 557, 297-306

Steinhauser D.R.: Actin filaments and bundles in flow, PhD thesis, Göttingen (2008)

Jo K., Chen. Y.L., De Pablo J.J., Schwartz D.C.: Elongation and migration of single DNA molecules in microchannels using oscillatory shear flows, Lab on a Chip (2009), 9, 2348-2355.

# Bending dynamics of nanofilaments, radius 70nm thermal fluctuations => evaluating flexibility A

Contour length: 42.3  $\mu\text{m}$   
Persistence length: 31  $\mu\text{m}$

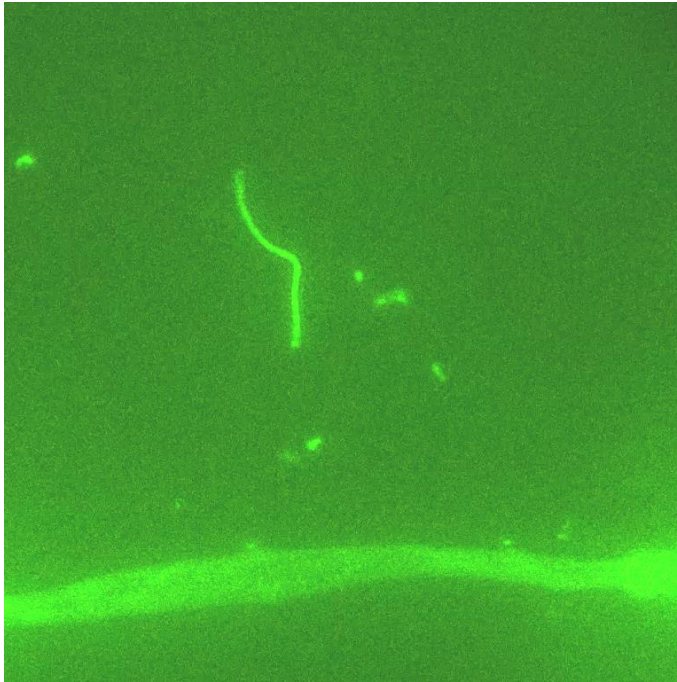

Contour length: 126.1  $\mu\text{m}$   
Persistence length: 56  $\mu\text{m}$

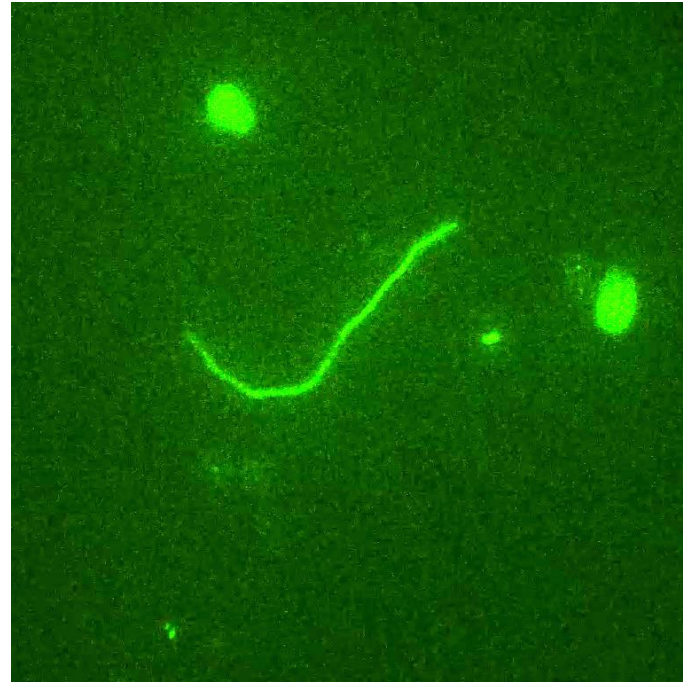



## Bead-Spring hydrodynamic model

### Simplified Hydrodynamics

$$\begin{aligned}\eta \nabla^2 \mathbf{v} - \nabla p &= \mathbf{0}, \\ \nabla \cdot \mathbf{v} &= 0,\end{aligned}$$

- Chain of spheres in Stokes approximation ( $Re=0$ )
- Neglecting Brownian fluctuations
- Time is parameter (step by step solution)

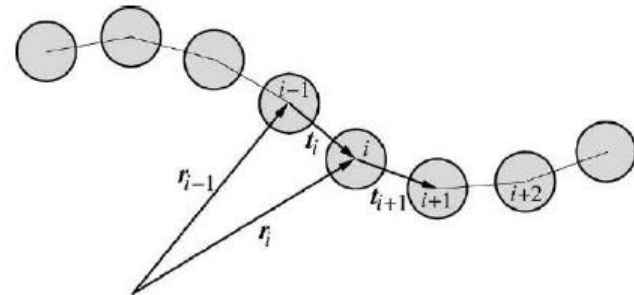
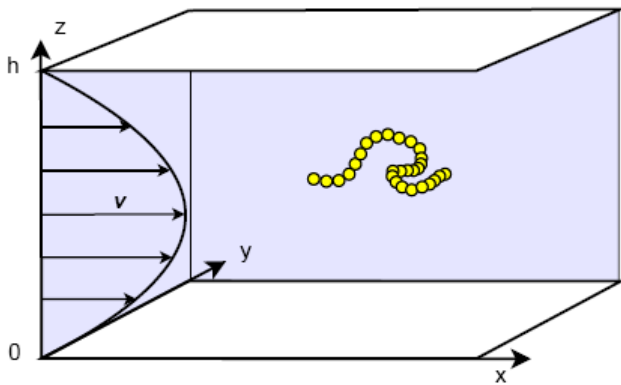

## Bead-Spring hydrodynamic model

Flipping and tumbling of fiber conveyed by channel flow.

Number of beads  $N=20$ ;

Relative Flexibility  $\underline{A}=0.5$ ;

Relative Extensibility  $\underline{k}=10$ .

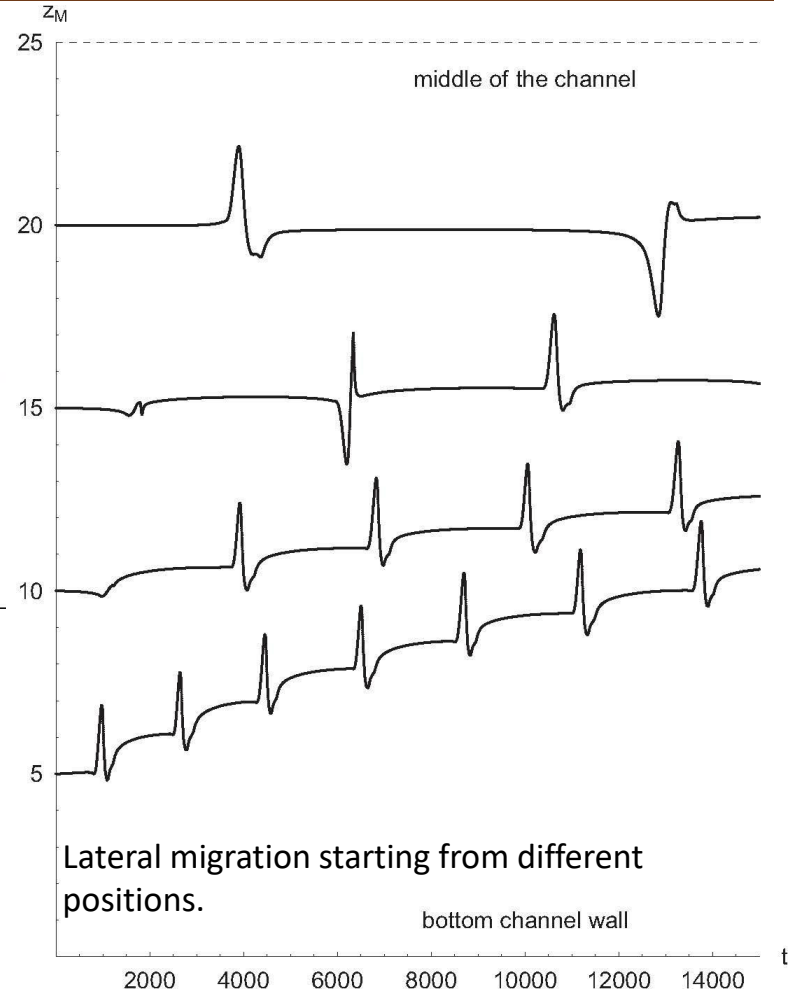
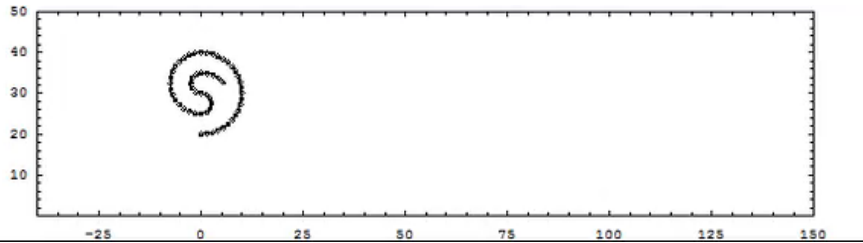

K. Sadlej, E. Wajnryb, M.L. Ekiel-Jezewska,  
D. Lamparska, and T.A.. Kowalewski,  
Int. J. Heat Fluid Flow 31, 996–1004 (2010).

## Bead-Spring Hydrodynamic Model

Flipping and tumbling => Is it related to long molecules hydrodynamics ?

Beads model:	DNA 100kbp experiment
$N = 5 - 20$ ( $d/L > 0.05$ )	=> $d/L < 10^{-4}$
Relative flexibility $\underline{A} = 0.5 - 20$	=> $\underline{A} = 2.5 \cdot 10^4$
Relative extensibility $\underline{k} = 10$	=> $\underline{k} = 52-100$

**Proposed hydrogel nanofilaments as experimental model**

$d = 120-150 \text{ nm}; L = 5 \mu\text{m} - 100 \mu\text{m}; E = 2 \text{ kPa}; L_p = 5 \mu\text{m} - 10 \mu\text{m}$

$$d/L = 0.03 - 0.005$$

$$\underline{A} = 10 - 160$$

$$\underline{k} = 16 - 350$$

**Includes Brownian fluctuations**

# Oscillating flow system

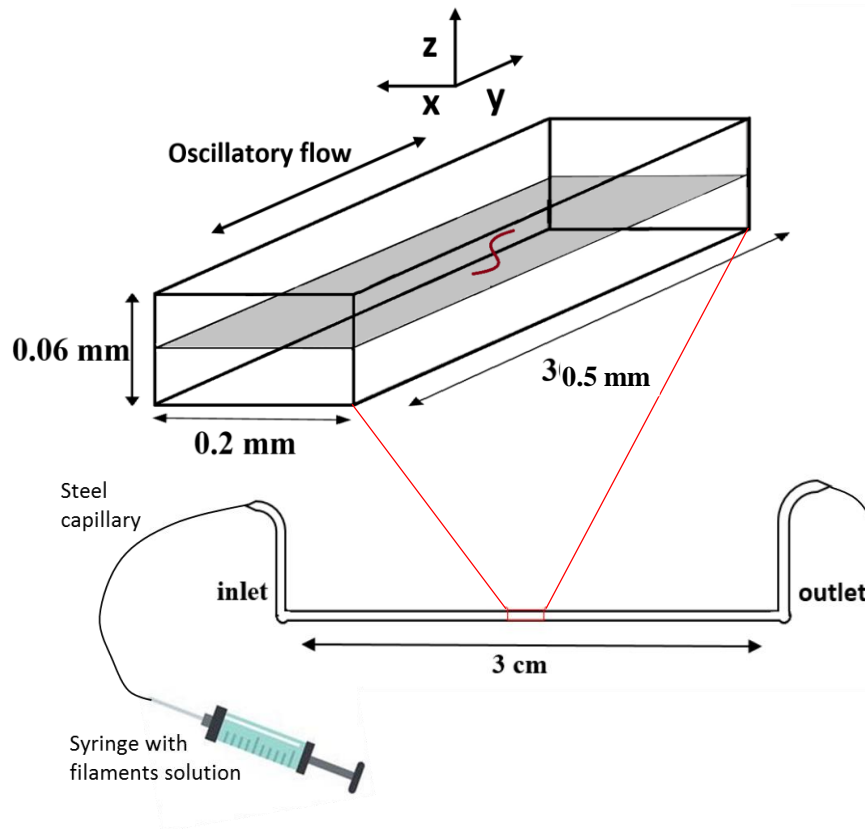

Elastic tube closed during oscillatory flow

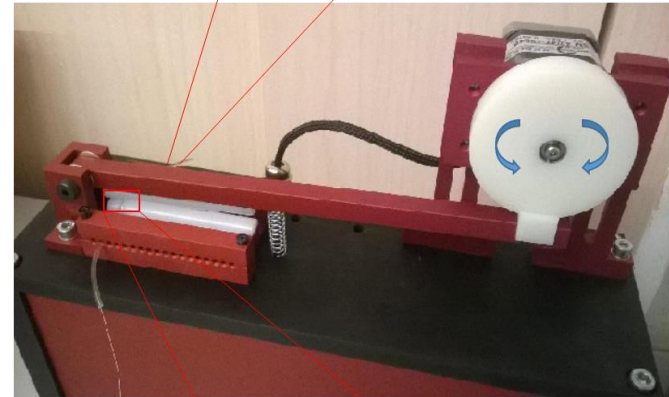
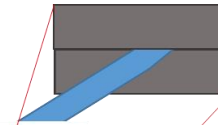

Elastic tube

# Hydrogel nanofilaments in oscillating flow

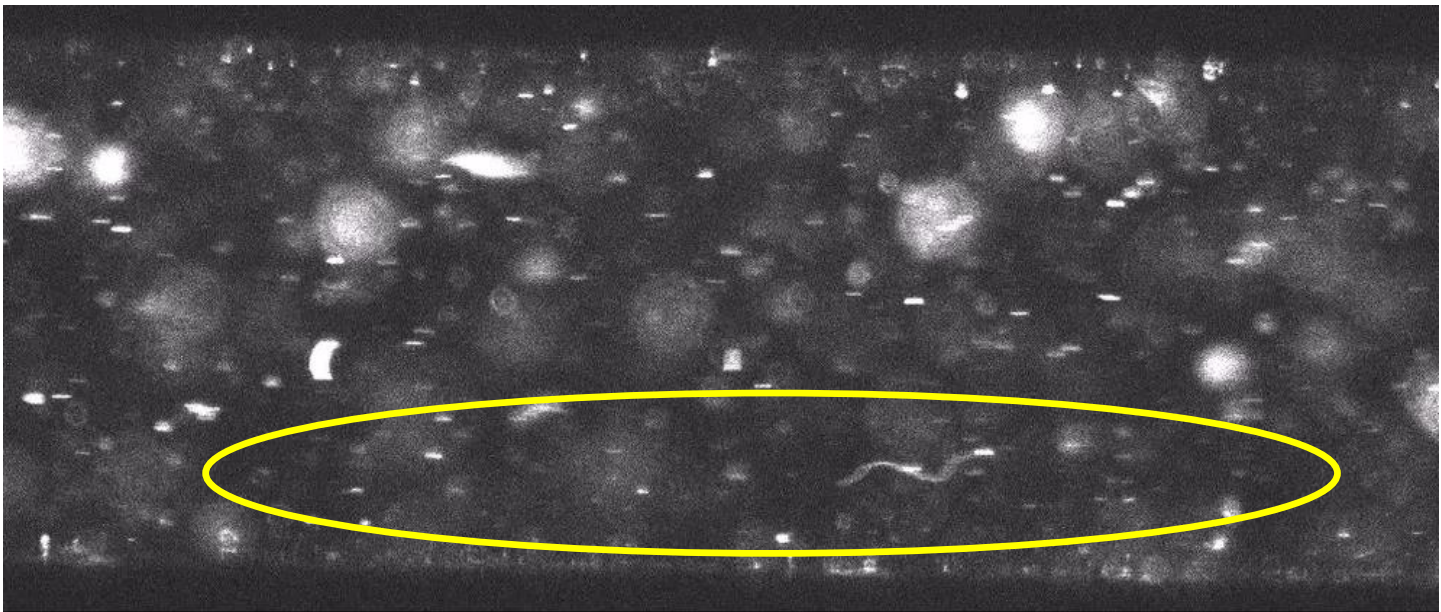

Vav [um/s]	L [um]	R [um]	Re (Dchannel)	Lp [um]	E [kPa]	Sp
68.87	61	0.067	3.11.10-2	7.51	2	47

# Flow profile during oscillating flow

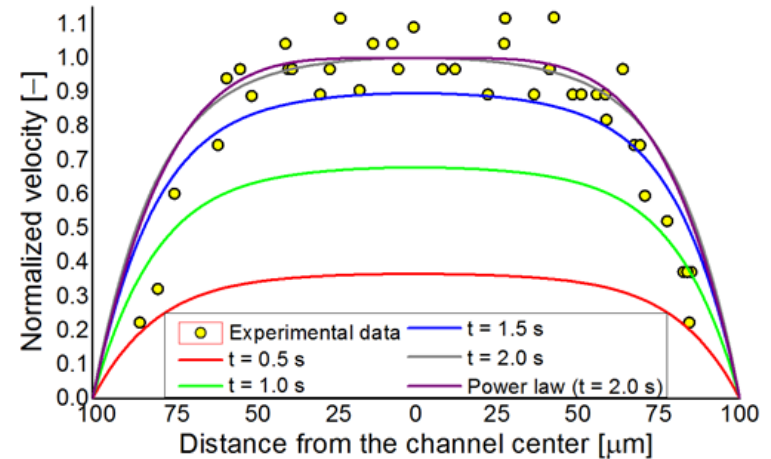
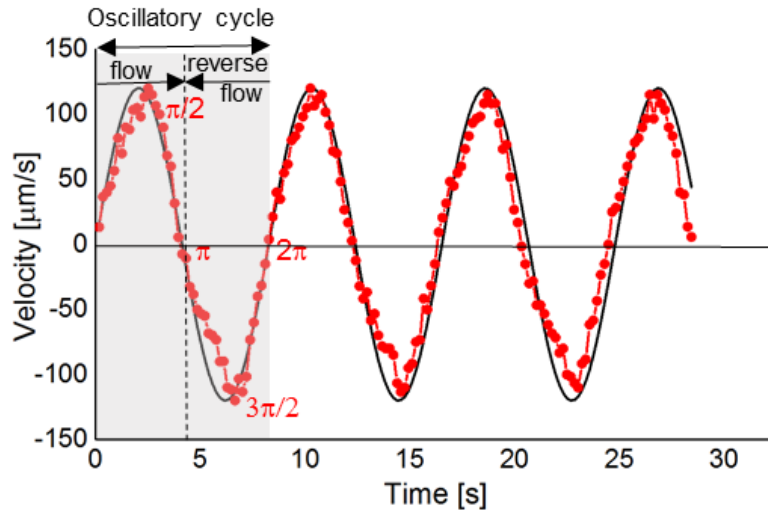

$$V(x, t) = V_{max} \left[ 1 - \left| \left( \frac{x}{w_h} \right)^{4.5} \right| \right] \cdot \sin(2\pi f t)$$

# Bahaviour of nanofilament under oscillating flow

Bent-like filaments

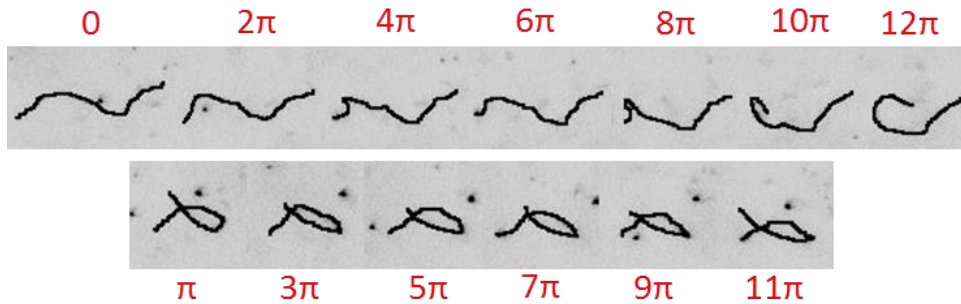

U-shaped filaments

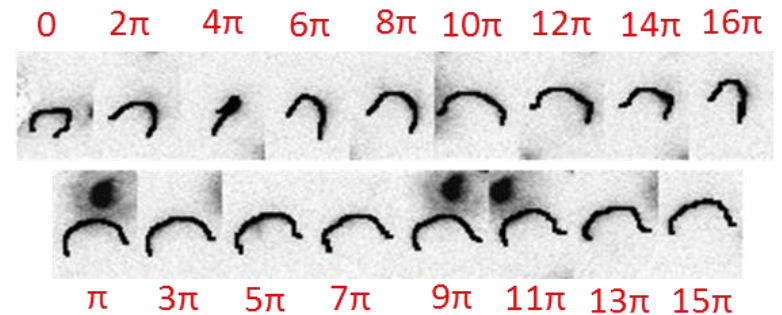

$d$	$140 \pm 19 \text{ nm}$	$128 \pm 27 \text{ nm}$
$L$	$65 \pm 17 \text{ }\mu\text{m}$	$31 \pm 5 \text{ }\mu\text{m}$
$L_p$	$10 \pm 4.3 \text{ }\mu\text{m}$	$7.5 \pm 7 \text{ }\mu\text{m}$
$L_p/L$	$0.15 \pm 0.04$	$0.25 \pm 0.2$
$V_r$	$0.001 \pm 0.0007$	$0.001 \pm 0.0008$

# Elongation parameter

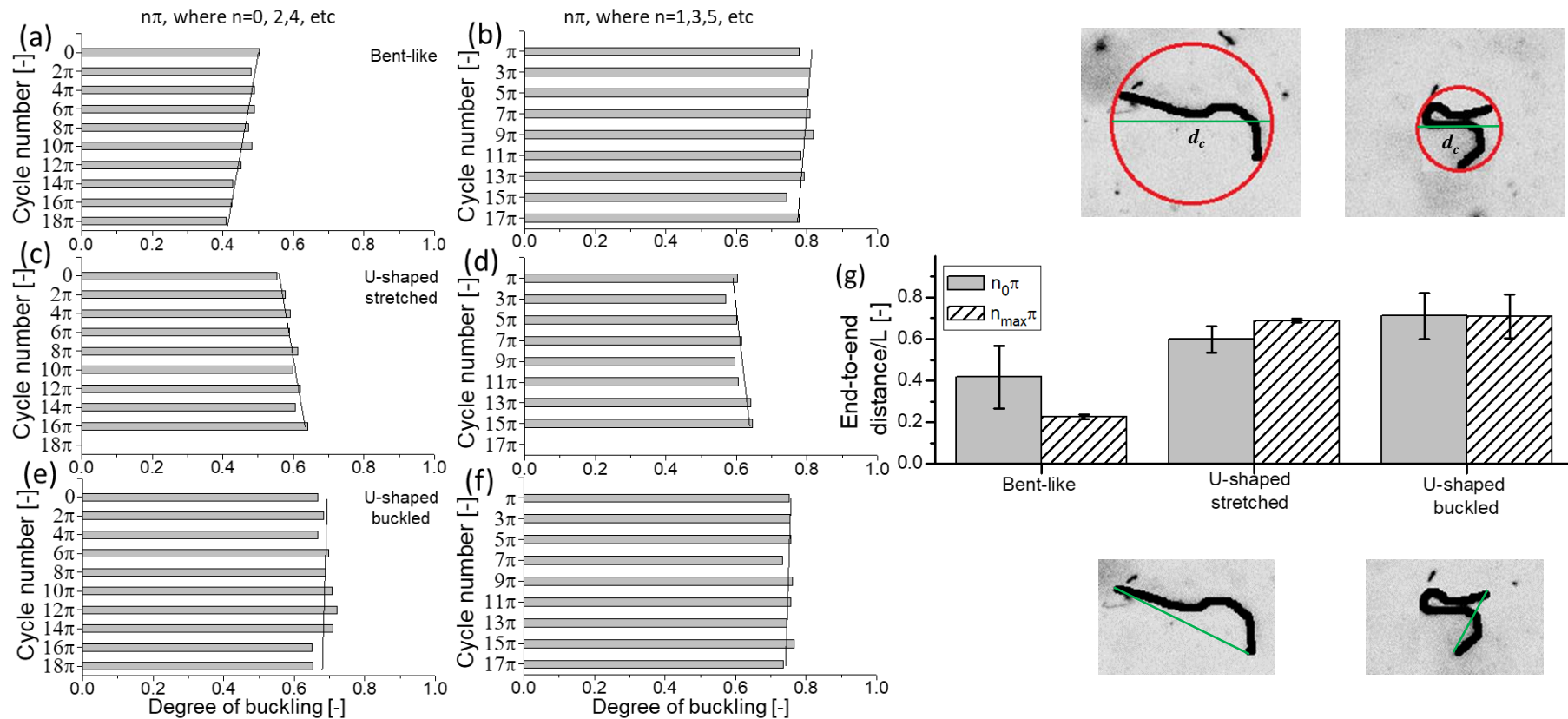



# Orientation – inclination angle

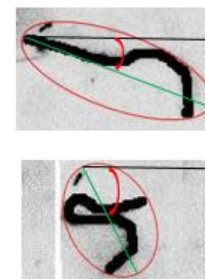
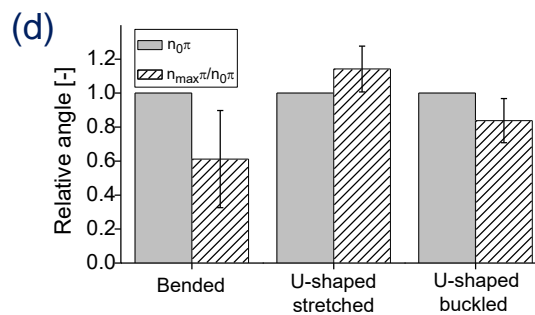
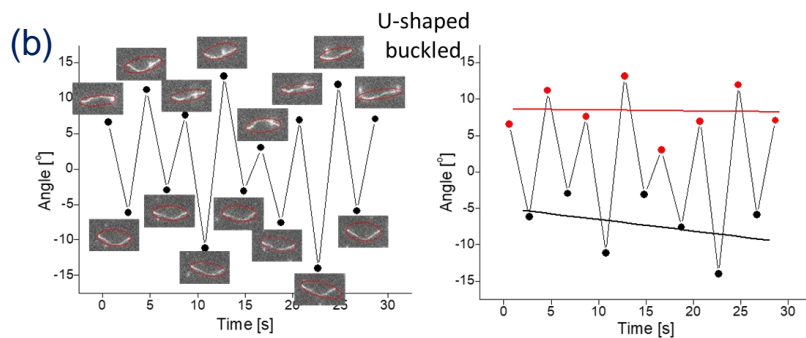
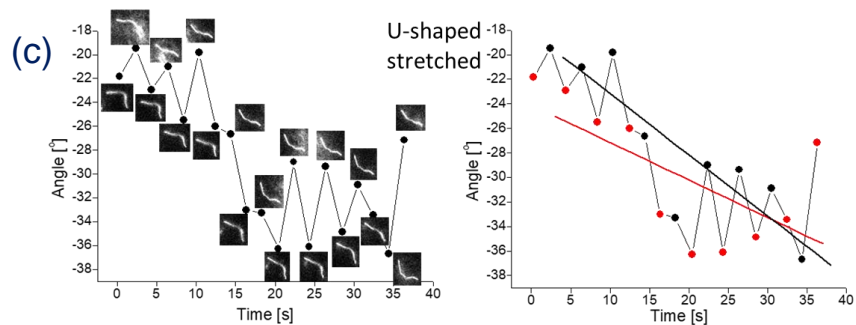
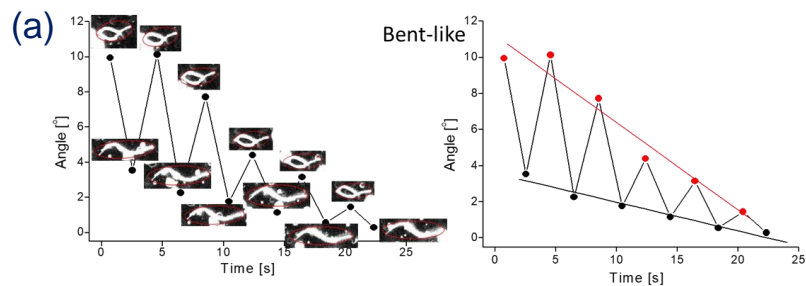

# Lateral migration

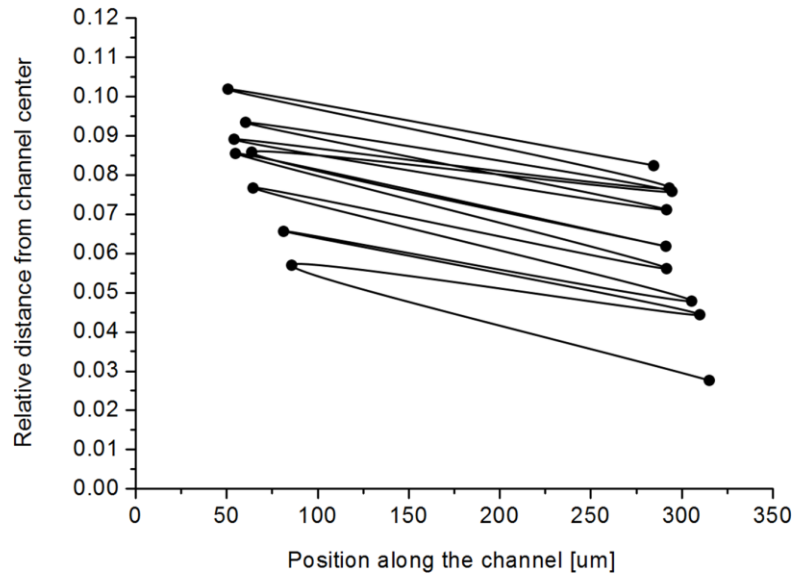

$R = 90 \text{ nm}$ ;  $L = 32 \text{ }\mu\text{m}$ ;  $L_p = 25 \text{ }\mu\text{m}$ ;  $Re = 0.07$ ;  
 $Sp = 3$ ;  $V_r = 0.0016$

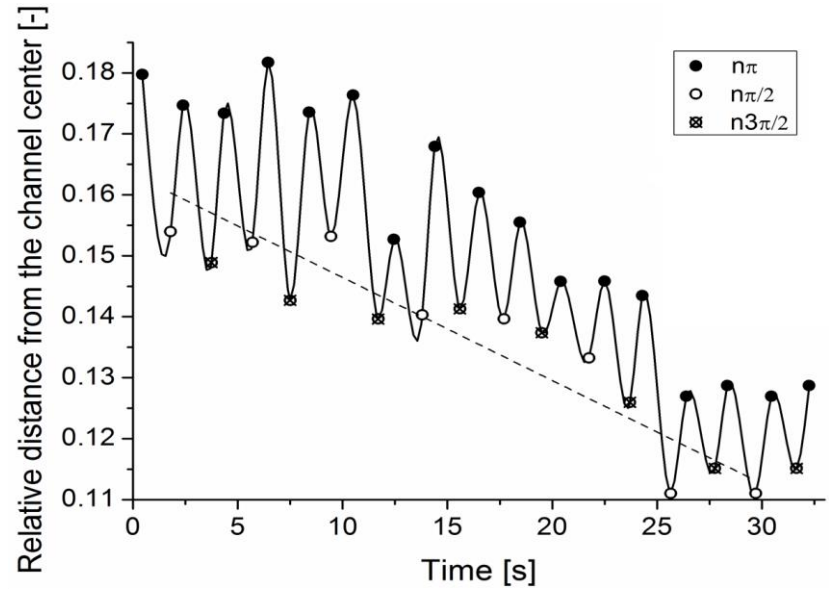

$R = 53 \text{ nm}$ ;  $L = 41 \text{ }\mu\text{m}$ ;  $L_p = 2.89 \text{ }\mu\text{m}$ ;  $Re = 0.06$ ;  
 $Sp = 10$ ;  $V_r = 0.0021$

# Lateral migration of hydrogel nanofilaments

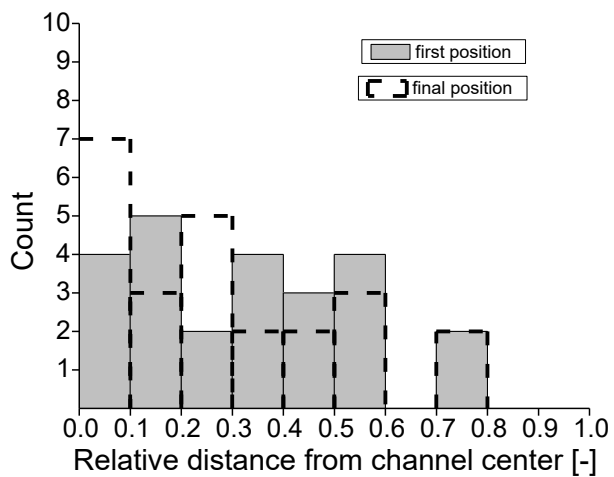

Bent-like filaments

$$V_{\max} = 145 \mu\text{m/s}$$

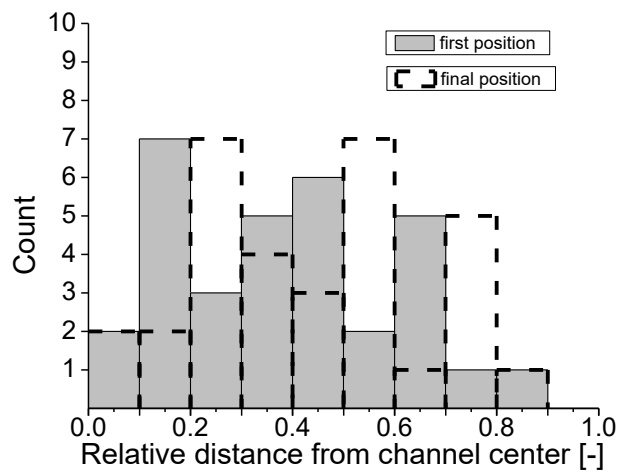

U-shaped stretched filaments

$$V_{\max} = 125 \mu\text{m/s}$$

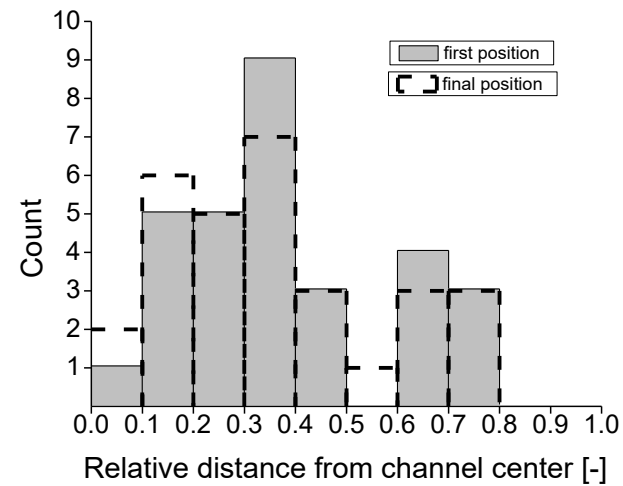

U-shaped buckled filaments

$$V_{\max} = 250 \mu\text{m/s}$$

# Conclusions

**Electrospinning technique** is very good method for closing hydrogel material in the form of filament.

**Mobility of nanofilaments** depends on several factors like flow velocity, persistence length, contour length, local shear stress, buckling-bending properties.

**Confirmed lateral migration** of deformable filaments

There is no evidence of predicted by the Stokesian model fiber flipping, i.e. sudden changes of orientation

**Brownian fluctuations** have rather secondary effects, stochasticity observed only at stop-flow time steps

Proposed experimental model may help to elucidate role of hydrodynamic interactions in describing physical phenomena responsible for the processes of folding and bending of long molecular chains (e.g. proteins, DNA).

Thank you for your attention!

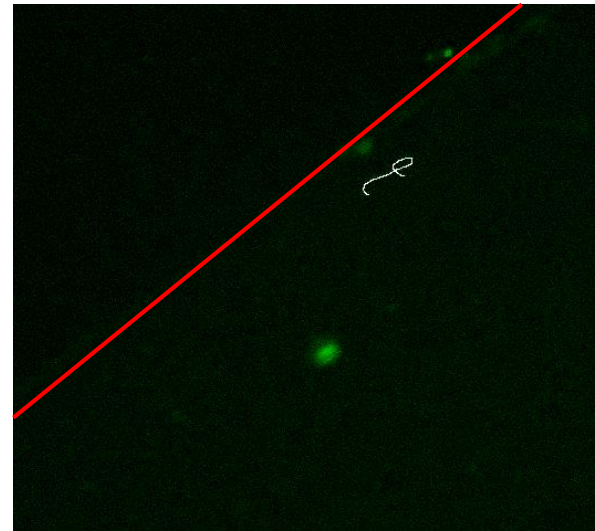
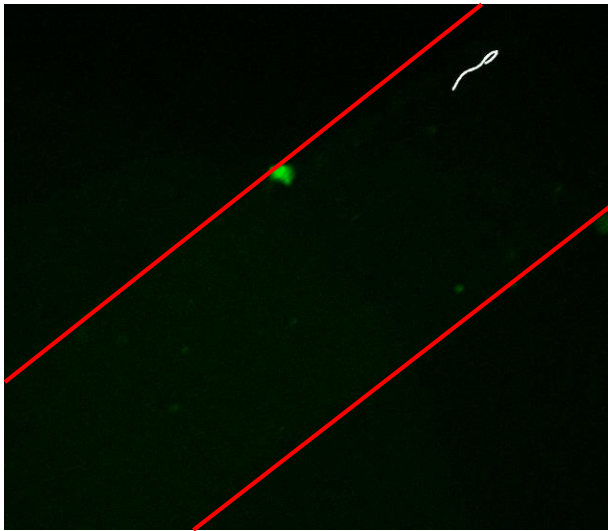

$U = 45\mu\text{m/s}$ ,  $L = 25\mu\text{m}$ ,  $R = 50\text{nm}$ ,  $D = 100\mu\text{m}$ ,  $Re_D = 4 \cdot 10^{-3}$