

## THE INFLUENCE OF THE TRANSDUCER BANDWIDTH ON THE EFFICIENT GOLAY CODES COMPRESSION

Ihor TROTS, Andrzej NOWICKI, Wojciech SECOMSKI,  
Ryszard TYMKIEWICZ

Institute of Fundamental Technological Research  
Polish Academy of Sciences  
Świętokrzyska 21, 00-049 Warszawa, Poland  
e-mail: igotr@ippt.gov.pl

*(received July 15, 2007; accepted October 2, 2007)*

The maximization of penetration depth with concurrent retaining or enhancement of image resolution constitutes one of the time invariant challenges in ultrasound imaging. To solve this problem a pulse compression technique employing long coded sequences is now under intensive investigation and in fact some of the corresponding techniques were already implemented in commercial scanning machines.

This paper investigates the influence of the effective bandwidth of the transducer on the behaviour of the encoding/compression technique and its potential influence on the axial resolution. We have investigated two different bits lengths – one and two periods – in the Golay sequences resulting in substantial difference of the bandwidth of the transmitted sequences. Three transducers with different fractional bandwidths were used in the experiments: 6 MHz focused transducer with 25% fractional bandwidth, 4.4 MHz flat transducer with 58% fractional bandwidth and 6 MHz flat, composite transducer with 80% fractional bandwidth. The experimental results are clearly showing that the elongation of the Golay single bit length (two cycles in our case) compensates for the limited transducer bandwidth. For 25% bandwidth peak-to-peak echo increased by 1.89 times; for 58% bandwidth peak-to-peak echo amplitude increased by 1.62 times, and for 80% bandwidth peak-to-peak echo increased by 1.47 times.

**Keywords:** ultrasound imaging, transducer bandwidth, Golay complementary sequences.

### 1. Introduction

Sound absorption in the tissue increases approximately linearly with frequency thus limiting the resolution in investigating deep structures. This limitation can be overcome by using long wideband transmitting sequences and compression techniques on the receiver side [1]. To this end different processing systems were proposed in both, Non Destructive Testing and in medical imaging. Basically, all systems use coded transmitted signals and employ correlation and averaging on reception of the echoes. Consequently

the high peak transmitted power is no longer required – the gain in signal-to-noise ratio (SNR) results from the compression of the echoes. Extensive comparison of the standard radiofrequency (RF) sine wave bursts compared to the random noise transmission and the subsequent compression using polarity coincidence correlator was done by BILGUTAY *et al.* [2]. They showed the SNR ratio enhancement especially when the integration time of the correlator was made arbitrarily long. However the requirements of the real time medical scanning do not permit extensive integration time and the attained SNR final gain depends on the length of the transmitted sequence and the efficacy of the compression algorithm.

There are several papers in literature concerning similar boundary-condition problem of signal compression in medical diagnostic imaging. The influence of the coding transmission on the lateral resolution was addressed in [3]. The improvement of the SNR in medical ultrasonic imaging was clearly demonstrated by HAIDER *et al.* [4]. The SNR gain was achieved by elongation of the excitation pulse and employment of the deconvolution filter with the deconvolution kernel being the excitation waveform. Authors concentrated on the analysis of the Barker codes of length 7 and 13 and pseudochirp signals.

Improvement in SNR and penetration depth in medical ultrasound by using long coded waveforms was reported by MISARIDIS *et al.* [5]. In that work an arbitrary function generator was used for the generation of the coded waveforms and the ultrasonic echoes were acquired with an 8-bit digital storage oscilloscope. In this work a chirp excitation was applied and the experiments were conducted at 4 MHz.

This paper helps to elucidate the influence of the transducer bandwidth on the burst and echo signal and explains why the short pulse does not always provide the better axial resolution than longer signals transmitted in the same ultrasonic transducer. Spectrum analysis can be used to measure the pulse characteristics of ultrasonic transducers in expressing the amplitude of an acoustic pulse as a function of frequency.

In our research we have concentrated on the assessment of the Complementary Golay Sequences (CGS). In comparison with other, earlier proposed coded excitation schemes, such as chirp, pseudo-random sequences and Barker codes, the CGS allow virtually side-lobe free operation.

The comparison of the experimental results obtained for transmission of two different bit lengths is given and the efficiency of the pulse compression and its influence on the axial resolution for two fractional bandwidths is discussed.

## 2. Generation of the Golay complementary sequences

Golay complementary codes exhibit the property of canceling the time (range) side-lobes. Complementary codes were introduced by Golay in the 1961. Golay codes are pairs of binary codes, belonging to a family of sequences called complementary pairs, which consist of two sequences of the same length with an auto-correlation (correlation for the case of ultrasonic echoes compression) functions having the side-lobes equal in magnitude but opposite in sign. Summing them up results in a composite auto-

correlation (correlation) function equals to  $2n$  and zero side-lobes [6]. The properties and the construction principle of the Golay complementary sequences are described in [7].

The reason for the elongation of the one-cycle bit to the two-cycles bit code is the fact that it has wider fractional bandwidth than the transducer, which results in attenuation of the one-cycle signal energy by an ultrasonic transducer. Coding method with two-cycle bit length extends the duration of each bit thereby narrowing the fractional bandwidth of each bit of the code. Hence, the total signal bandwidth is narrower. Naturally the average transmitter energy doubles as well.

Golay sequence with two-cycles 8-bits length and Golay sequence with one-cycle 16-bits length at the nominal frequency 6 MHz are shown in Fig. 1.

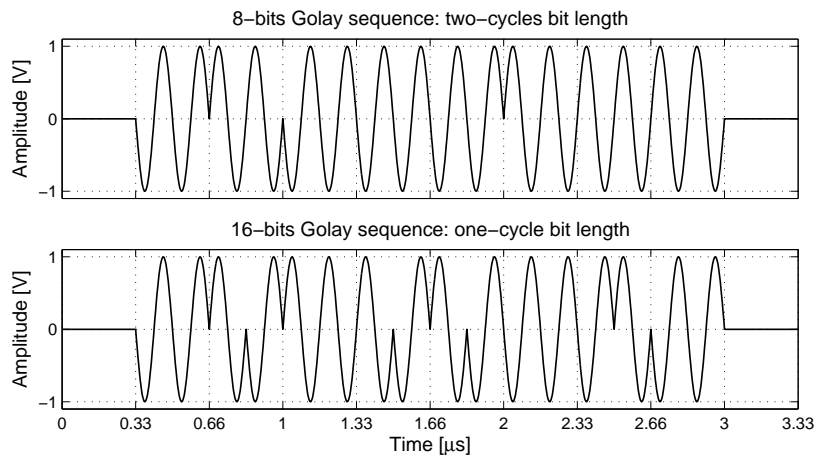

Fig. 1. Comparison of two coding methods of the Golay sequences at nominal frequency 6 MHz: 8-bits code with two-cycles bit length (top) and 16-bits code with one-cycle bit length (bottom).

Figure 2 presents the spectra of the 8-bits and 16-bits Golay sequences with different bits length – two and one cycles, respectively.

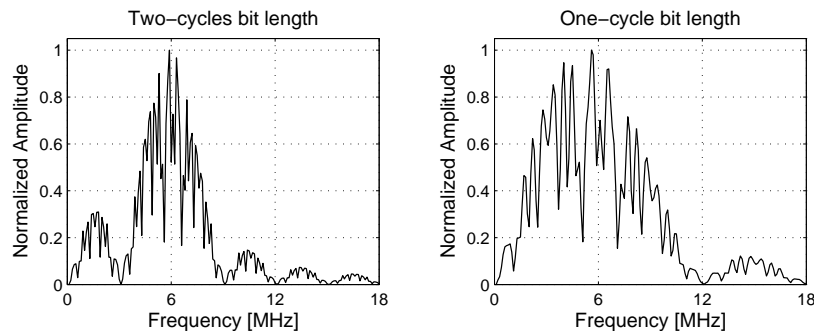

Fig. 2. Power spectra of the Golay complementary sequences at centre frequency 6 MHz with different bits length: 8-bits code with two-cycles bit length (left) and 16-bits code with one-cycle bit length (right).

Plots in Fig. 2 clearly demonstrate the advantage of narrowing of the transmitted spectra in case of two-cycles versus one bit coding. The signal bandwidth in this case is two times narrower than for the traditional one, being close to 50% and better fitting the bandwidth of standard transducers.

### 3. Materials and methods

The purpose of this study is to show the advantage of the coding method with elongated bit length in the Golay complementary sequences. Three transducers with different fractional frequency bandwidth were used in the experiments. The obtained results show similar axial resolution for one and two cycles bit length, especially for decreasing transducer bandwidth.

#### 3.1. Measurement system

The block diagram of the experimental setup is shown below in the Fig. 3.

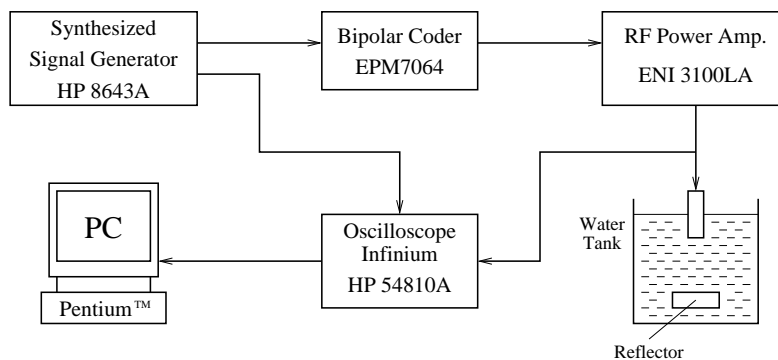

Fig. 3. The experimental setup.

The Golay sequences at frequency 6 MHz or 4.4 MHz with different bit lengths were synthesized using Signal Synthesizer (HP8643A, Agilent, USA). This signal was connected to the bipolar programmer coder (EPM7064, Altera™, USA) that allowed to generate switched pair of 16-bits Golay sequences with one-cycle bit length and 8-bits Golay sequences with two-cycles bit length. After amplification in the power RF amplifier (ENI 3100LA, USA) the transmitted burst excited the ultrasonic transducer immersed in a water tank. The excitation voltage applied to the ultrasonic transducer was equal to 50 V (peak-to-peak) for all transmitted sequences in order to keep the  $I_{SPTP}$  intensity constant.

The RF echoes data were acquired using a digital storage 12-bits oscilloscope (Infinium, HP 54810A, USA), with a sampling rate of 25 MHz. Next, the collected digital data were processed off-line and displayed on the oscilloscope. All post processing and

display is done on the computer using Matlab<sup>®</sup> routines. The processing included amplification, pulse compression for Golay sequences, and envelope detection and takes few seconds for each individual scan line.

#### 4. Experimental results and discussion

The peak pressure level at all transducers was the same for all Golay coded sequences.

The effect of transducer bandwidth on the transferred signal can be shown on the echo signal in time domain. Because the visual results of echo signals are not considerably different only two cases are shown, in which the transducer bandwidth is equal to 25% and 80%. Figures 4–5 show the measured RF echo signals of the one from the pair of the 16-bits Golay complementary sequences with one-cycle bit length and 8-bits Golay complementary sequences with two-cycles bit length reflected from the plexiglass flat reflector of thickness 1.3 mm normally oriented to the ultrasonic beam. The frequency bandwidths of the burst Golay sequences and transducers are also shown.

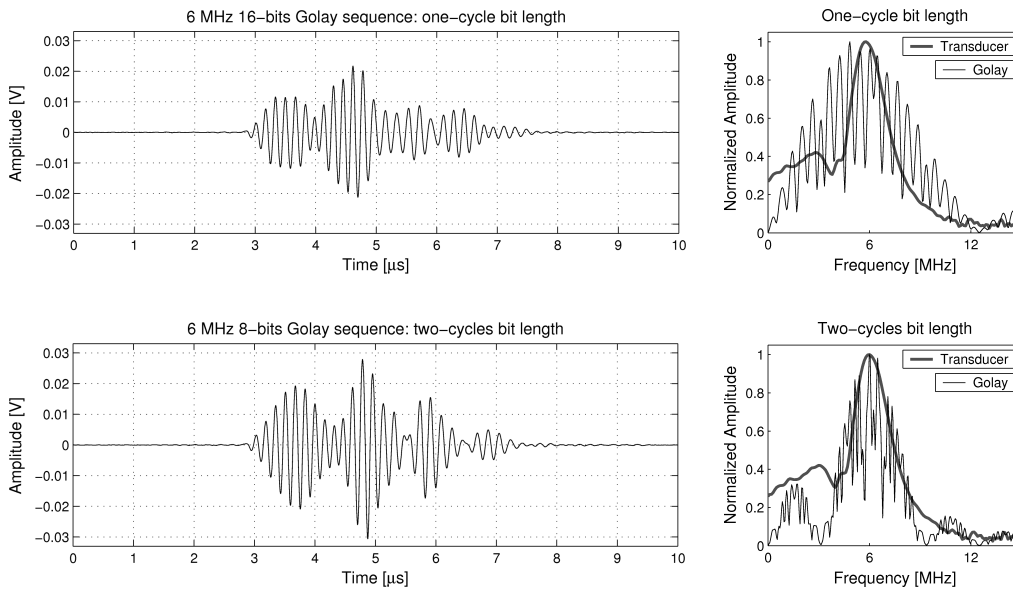

Fig. 4. RF echo signals from the pairs of the 16-bits and 8-bits Golay codes reflected from the plexiglass plate (left) with one-cycle bit length (top) and two-cycles bit length (bottom) when 6 MHz transducer with 25% fractional bandwidth was used. The spectrum of the transducer (bold) and coded sequences (thin) are shown (right).

The different amplitudes of the echo signals are related to the bit length of the coded sequence and the limited bandwidth of the ultrasonic transducers. In the case of the double bit length, the amplitudes of the echo signals are evidently higher.

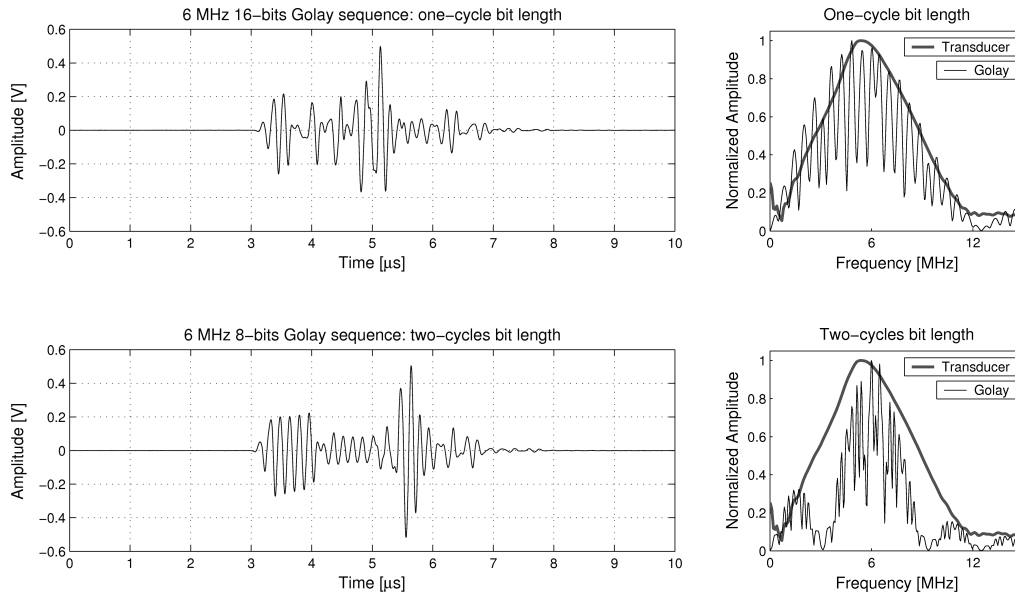

Fig. 5. RF echo signals from the pairs of the 16-bits and 8-bits Golay codes reflected from the plexiglass plate (left) with one-cycle bit length (top) and two-cycles bit length (bottom) when 6 MHz composite transducer with 80% fractional bandwidth was used. The spectrum of the transducer (bold) and coded sequences (thin) are shown (right).

The echoes after compression applied are shown in Figs. 6–7. These experimental results clearly demonstrate both, the effect of increasing of the transmitted/received signal energy and maintaining of the axial resolution when the bit length extends.

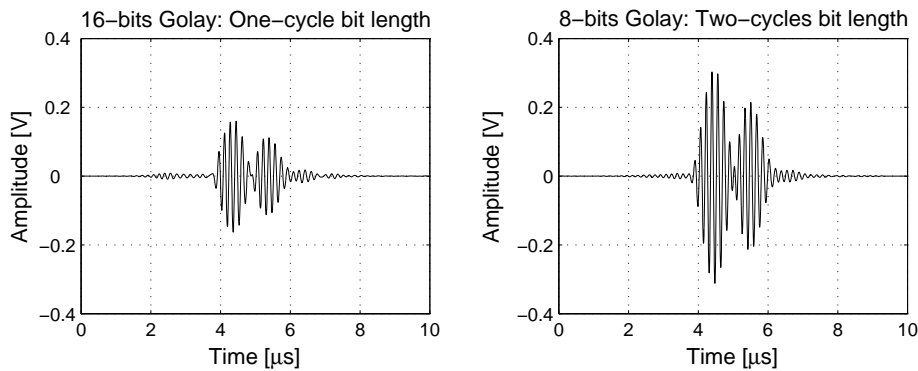

Fig. 6. Compressed RF echo signals reflected from the plexiglass plate of thickness 1.3 mm obtained with 6 MHz focused transducer, 25% fractional bandwidth.

From the obtained compressed echoes in Figs. 6–7, it can be shown that the transducer bandwidth has a crucial influence on the transferred energy. The use of two-cycles

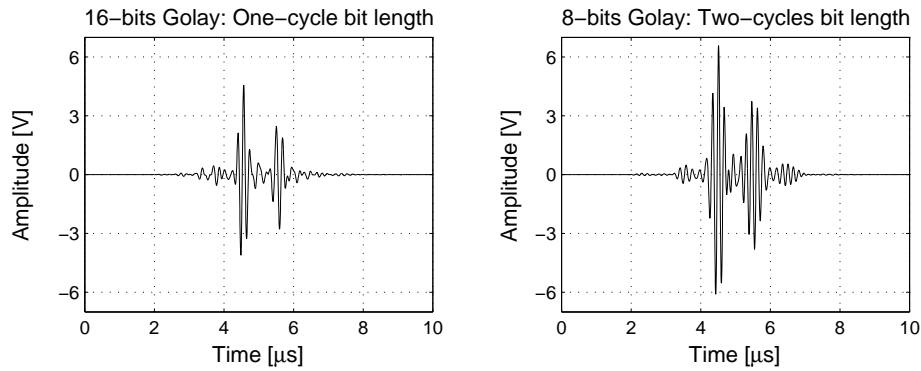

Fig. 7. Compressed RF echo signals reflected from the plexiglass plate of thickness 1.3 mm obtained with 6 MHz composite transducer, 80% fractional bandwidth.

bit signal narrows the transmitted frequency spectrum in comparison with the one-cycle one and allows optimization of the pulse-echo sensitivity. In the case of 25% fractional bandwidth, extending of the bit length allows to increase the peak-to-peak amplitude of

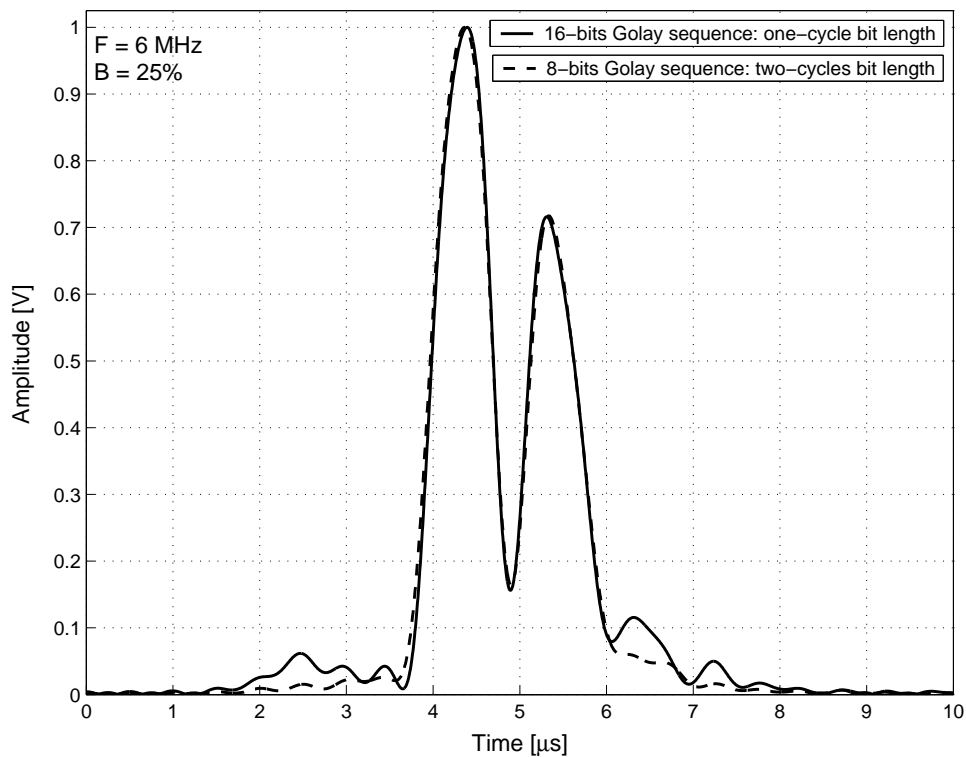

Fig. 8. Comparison of the envelopes of echoes in case of using 25% fractional bandwidth with nominal frequency 6 MHz focused transducer.

the compressed signal by factor of 1.89 (Fig. 6). For 58% fractional bandwidth elongation of the code bit length increases of the peak-to-peak signal amplitude by factor of 1.6. For 80% fractional bandwidth elongation of the code bit length increases of the peak-to-peak signal amplitude by factor of 1.47 (Fig. 7).

To examine objectively the axial resolution the envelopes of the compressed RF echoes are shown in Figs. 8–9.

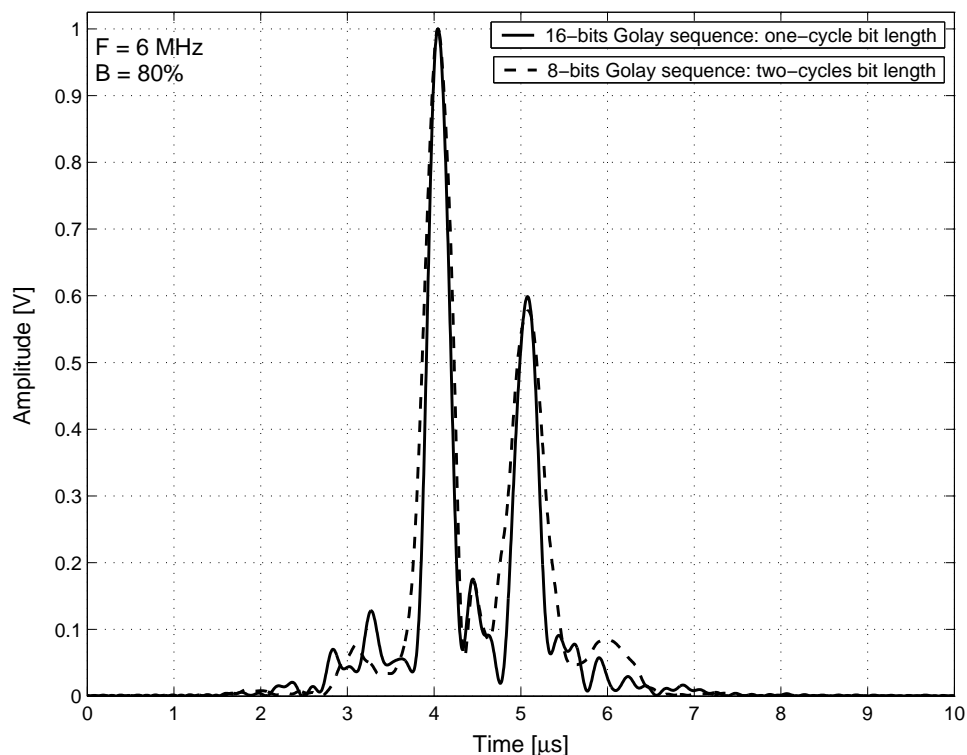

Fig. 9. Comparison of the envelopes of echoes in case of using 80% fractional bandwidth with nominal frequency 6 MHz composite transducer.

Figures 8–9 show the comparison of the envelopes obtained applying the different bits lengths – one and two periods – in the Golay sequences. For narrow transducer bandwidth (in given case 25%) the resolution is almost the same. The width of the compressed pulses is equal to 1.09 mm for one-cycle bit length and 1.12 mm for two-cycles bit length at level  $-6$  dB (Fig. 8). With widening of the transducer bandwidth the resolution is only slightly different. The width of the compressed pulses is equal to 0.71 mm and 0.95 mm for the 4.4 MHz transducer with 58% fractional bandwidth. The width of the compressed pulses is equal to 0.44 mm and 0.57 mm for the 6 MHz transducer with 80% fractional bandwidth (Fig. 9). In clinical ultrasound practice such change in resolution will be indiscernible.



## 5. Conclusions

This work addressed the problem of improving the echoes' amplitude without decreasing the axial resolution. To solve this problem the bit length in the Golay complementary sequences was elongated narrowing the fractional bandwidth of the coded sequences. Therefore more energy of the burst signal can be transferred through the ultrasonic transducer.

The results of this work clearly show that the axial resolution in case of using Golay sequences with two-cycles bit length and one-cycle bit length depends on the transducer bandwidth. The difference in width of compressed pulse at level  $-6$  dB is equal to 2.7% for the narrow transducer bandwidth and is equal to about 30% for the wide transducer bandwidth. But the amplitude of the obtained signal in the case of coded sequences with two-cycles bit length is from 1.89 to 1.47 times higher than in case of coded sequences with one-cycle bit length depending on the frequency bandwidth of the ultrasonic transducer. It gives grounds to suppose that the narrower fractional bandwidth of the coded excitation allows deeper penetration in abdominal organs/tissue. It is very important, especially in ultrasound diagnostic, since rather low amplitude transmitting peak pressure are required.

The analysis of the results proved that increasing the length of the individual bits in the Golay sequences is a good solution of narrowing fractional bandwidth without deteriorating the axial resolution as long as the fractional bandwidth of the code signal is wider than the one of the transducer used.

## Acknowledgment

This work was supported by the Polish Ministry of Science and Higher Education grant N51502732/1964.

## References

- [1] ROBINSON E. A., TREITEL S., *Geophysical signal analysis*, p. 466, Englewood Cliffs: Prentice-Hall, 1980.
- [2] BILGUTAY N. M., FURGASON E. S., NEWHOUSE V. L., *Evaluation of the random signal correlation system for ultrasonic flaw detection*, IEEE Trans. on Sonics and Ultrasonics, **SU-23**, 5, 329–333 (1976).
- [3] NOWICKI A., KLIMONDA Z., LEWANDOWSKI M., LITNIEWSKI J., LEWIN P. A., TROTS I., *Comparison of sound fields generated by different coded excitations-Experimental results*, Ultrasonics, **44**, 1, 121–129 (2006).
- [4] HAIDER B., LEWIN P. A., THOMENIUS K. E., *Pulse elongation and deconvolution filtering for medical ultrasonic imaging*, IEEE Trans. Ultrason. Ferroelect. Freq. Contr., **45**, 1, 98–113 (1998).

- [5] MISARIDIS T. X., GAMMELMARK K. KIM, JORGENSEN CH. H., LINDBERG N., THOMSEN A. H., PEDERSEN M. H., JENSEN J. A., *Potential of coded excitation in medical ultrasound imaging*, *Ultrasonics*, **38**, 183–189 (2000).
- [6] GOLAY M. J. E., *Complementary serie*, *IRE Trans. Inf. Theory*, **IT-7**, 82–87 (1961).
- [7] TROTS I., NOWICKI A., SECOMSKI W., LITNIEWSKI J., *Golay sequences – side-lobe-canceling codes for ultrasonography*, *Archives of Acoustics*, **29**, 1, 87–97 (2004).
- [8] RITTER T., GENG X., SHUNG K., LOPATH P. D., PARK S., SHROUT T. R., *Single crystal PZN/PT-polymer composites for ultrasound transducer applications*, *IEEE Trans. Ultrason. Ferroelect. Freq. Contr.*, **47**, 4, 792–800 (2000).